

VGM-1041 DSP Gated Mixer / EQ

Installation and Use

ACI-ApplicAD, Inc.



Manual & Firmware version 2.04
Applies to Serial Number Series 15198010035 and above

(732) 751-2555

www.aci-applicad.com

Table of Contents

Introduction -----	1
Features & Benefits	
Quick Start Guide -----	2
Basic Connections	
Basic Operation	
Operator's Guide -----	6
Front Panel Controls & Indicators	
Managing Microphones	
How Sound Gating Works	
Double Hall Operation	
Installer's Guide -----	15
Mounting, Rear Panel Wiring & Switches	
Microphone Channel Assignments	
Line Outputs	
Adjusting Power Amplifier Gain	
Factory Default Settings	
USB Settings	
Auto-EQ	
Graphing Frequency Response	
Double-Hall Installation	
In Case of Difficulty -----	44
Troubleshooting	
Phone Support & Warranty	
Specifications & Flow Diagram -----	46
Index -----	48

Introduction

The **VGM-1041 DSP Gated Mixer / EQ** targets sound reinforcement applications, so your audience enjoys higher quality sound than with generic mixers or consoles. Operators see a compact, refreshingly simple exterior – enabled by the adjustments which you or your installer set up at installation. Its rugged construction should provide you with years of reliable service.

Features and Benefits

The challenges often encountered running a sound reinforcement system inspired the features of this mixer, as shown below:

VGM-1041 Feature	What It Does	User Benefit
Mic Sound Gating with Last Mic ON & Adaptive Threshold	Quiets idle mics by gating only active ones ON. The last live mic remains ON until another is used.	Reduces distracting noise, allows for more volume with less reverberation and feedback.
Gate/Clip LEDs, LED Level meter	Shows inputs gated ON, clipping inputs, and overall level.	You know what's happening.
Selectable Compression	Limits unusually loud sounds, LED indicates when active.	Listeners remain comfortable.
Built-in Equalizers & Pink Noise Gen.	Separate mic & aux parametric EQs, pink noise for setup.	Vocal & program sources sound their best, all in one rack space.
Selectable De-Esser on Mics 1-8	Advanced DSP algorithm limits sibilance while preserving highs.	Spare audience from terribly excessive S and T sounds.
USB Setup Port	Configure EQ and many more functions via computer.	Set up advanced options at installation, & then hide them!
Industrial-quality active level controls	Withstands millions of rotations, controls volume via DSP.	Controls remain smooth and quiet for life.
Handles up to 10 mics + two Aux sources	Enough for nearly any use. Unused mic channels can be repurposed.	Suitable for nearly any mono sound-reinforcement application.
New! Mix-minus option for auditorium linking	Mic channels 9 & 10 can be used to link two VGM-1024s together.	Foolproof two-way program sharing for an overflow audience.
Input gain presets	Adapts to a 30dB source range.	Makes level setting easier.
Auto EQ Setup option	Adjusts Voice EQ to your acoustics.	Provides a quick setup choice.
Four balanced Outputs	Main, Voice, Music, & Stage Mon.	Handles most installations.
Compressed RCA Output	For FM Transmitter, recorder, etc.	Ready source for these uses.

Quick Start Guide

Basic Connections

Here's how to "bench test" your mixer – just plug in some cables and put sound through it. If desired you can skip directly to the **Installer's Guide** which fully describes installation details, but the experience you gain by working through this section may help when installing the unit:

Place your *VGM-1041* on a table or other flat surface.

Audio Source – Using a stereo RCA cable (the sort which often comes with audio components), connect a CD player or a similar "line level" audio source to both **AUX** inputs.

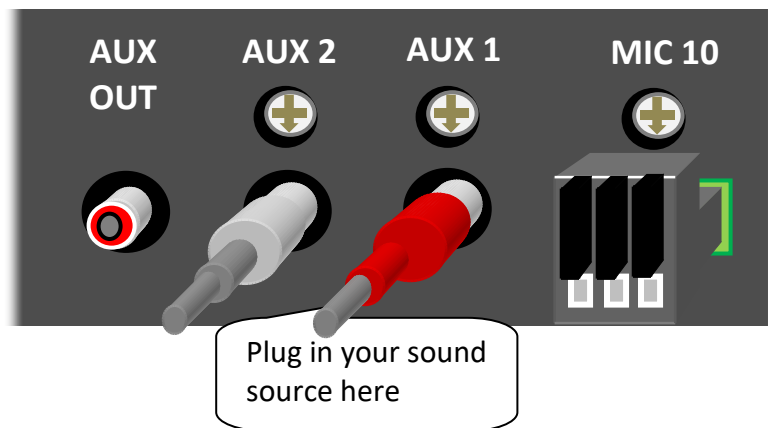

Amplifier – Connect your amplifier's balanced, line-level (not mic-level) input to the mixer's MAIN balanced output. Leave the amplifier switched OFF for the moment. Or connect an amplified computer speaker (etc.) to the MAIN output RCA jack; however, this output includes a volume limiter & bass rolloff.

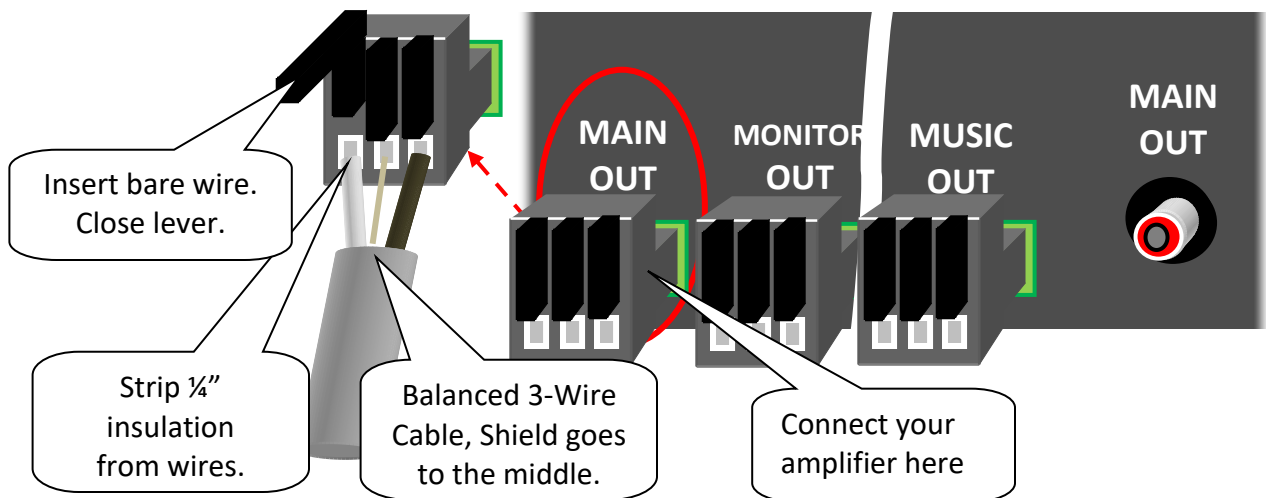

Quick Start Guide

Power – Now for the easy part: Find the supplied 24VDC power adapter. Plug its end into the **24 VDC** jack; plug the other end into a power outlet. Your mixer powers ON immediately (some of the DC adapters we supply take a few seconds to start up, this is normal). There's no power switch, since mixers of this sort are usually installed as part of a sound system – and with no switch to leave OFF by mistake, there's one less thing to go wrong! A powered *VGM-1041* always shows at least one illuminated LED on its front panel.

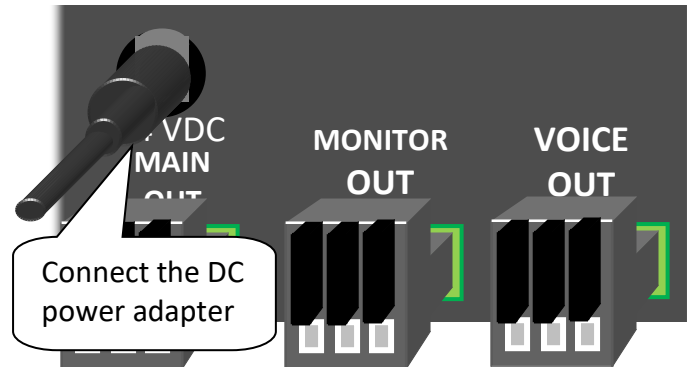

Level Meter – Start your audio source playing. On your mixer's front panel, increase both **AUX** controls until you see an indication about halfway up on the **LED level meter**.

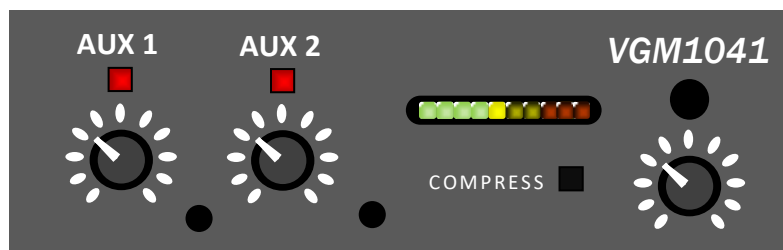

Is This Thing Working? – Turn down your amplifier's **gain** or **volume** control, and then power it ON. Advance the control until you hear your sound playing.

It's In Your Head – If you have a pair of headphones handy, plug them into the jack at the far right – the sound appears there as well. The knob directly under the headphone jack controls your headphone volume.

Quick Start Guide

Hi, Mike! – Connecting a microphone is a bit more challenging – since this mixer is designed for installation, its mic connectors are tool-less terminal blocks. Thus, on-stage cables terminated with XLR (A3M) connectors won't fit directly. If you have an old cable handy, you could cut it and wire its cut end as shown. Just insert the bare wire ends and close the levers:

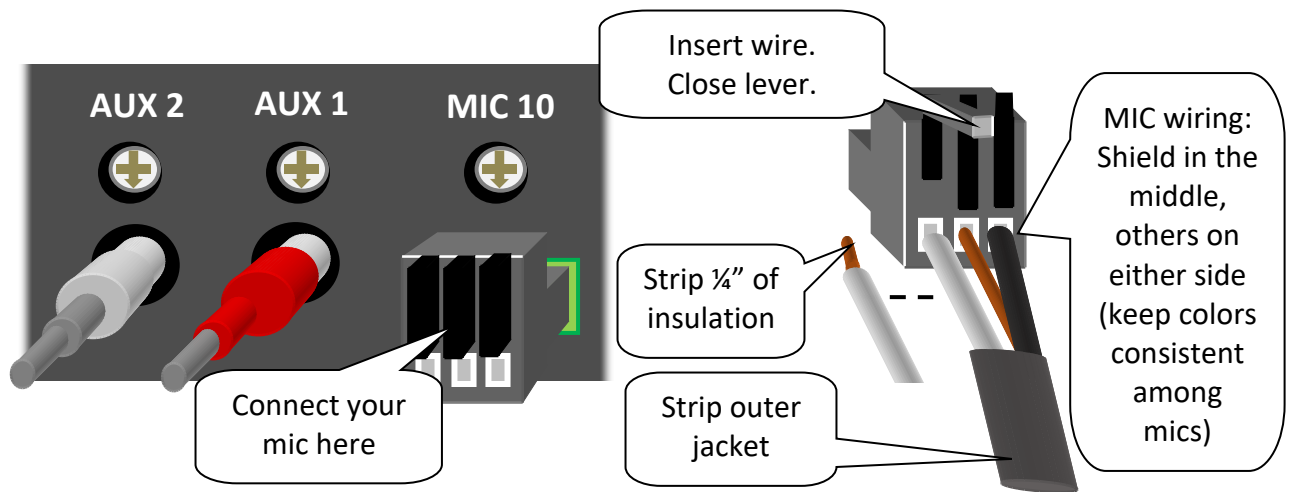

Connect your microphone to the cable's free end.

If your microphone is a condenser type, activate **phantom power** (this is how condenser mics get their supply) by setting the appropriate rear panel switch:

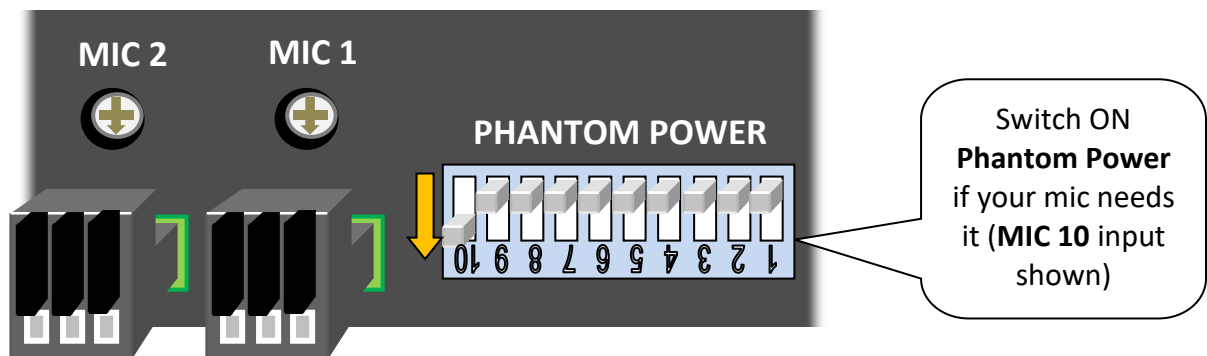

Quick Start Guide

Basic Operation

Now, bring up the level control corresponding to your mic. As you'll speak into the mic, you'll see several things happen:

- The **LED** above this level control shows **green**, indicating that this mic is **gated ON**. *Gating* activates each mic when it's receiving sufficient sound. Other mics remain muted, so they don't contribute to background noise and feedback. Thus, you get more sound with less distraction.
- Of course, the **level meter** indicates the sound level.
- Speak loudly enough, and you'll see the **COMPRESS** LED illuminate. The *VGM-1041's* built-in compression is limiting this mic's level, preventing excessively loud sound. This feature is selectable for each mic via the mixer's USB port (covered in the **Installer's Guide** section). The factory setting activates compression for all mic channels *except* **MIC3**.

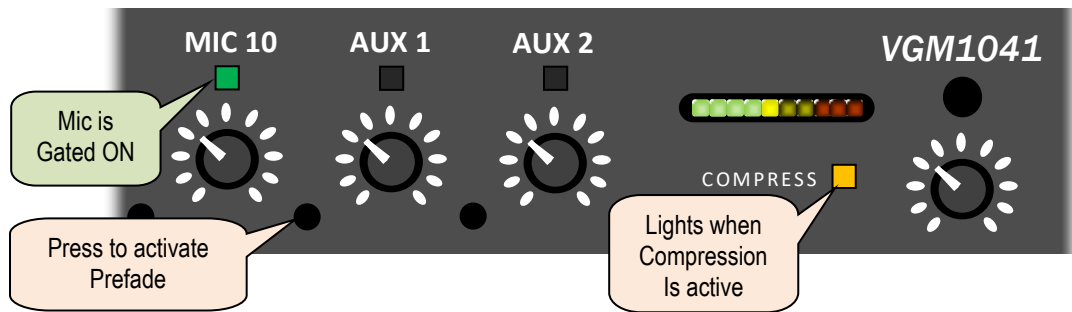

If you play the audio source you have connected to the AUX inputs earlier, you'll hear both the mic and the audio together (it's a mixer, after all!), from both your amplifier and the front-panel headphone jack.

Prefade – While listening to the mix on your headphones, press the small button to the right of your mic's knob. This puts your mic on the **Prefade** (cue) bus. Now, you hear only this mic through the headphones, even when its control is turned down to zero. This feature allows you to monitor any input before or without turning it up – helping to prevent unwanted surprises. Press the **Prefade** button again to return to main output at the headphones.

Operator's Guide

With the *VGM-1041* mounted as part of your sound system and set up according to the **Installer's Guide** later in this manual, operation is as simple as it could be!

Front Panel Controls & Indicators

Power – When you power up your sound system, the *VGM-1041* goes through a self-check routine which among other things, lights up all front panel LEDs in sequence. Once this “light show” finishes, your mixer is ready to use.

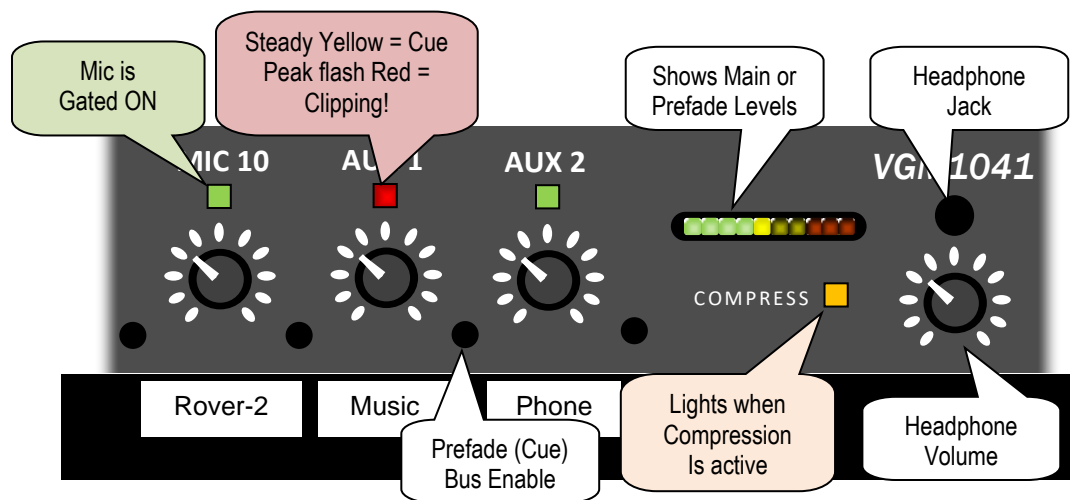

Gain controls – adjust as needed for good listening levels. You can apply labels on a blank panel above or below your mixer (as shown here) to describe their actual use. Depending on the microphones and their placement, about halfway to 2/3 up should provide good usable level. If not, ask your system's installer whether they have set the rear panel **gain preset** switches (see Page 15). The gating and compression features mean you'll do less knob-turning than would be needed with non-automatic mixers.

Gate/Clip LEDs – above each microphone gain control. Each lights **green** when the mixer gates that microphone ON. Use these LEDs to identify live mics. These LEDs light **yellow** when **Prefade** is active, and **red** when their input channels are in danger of “clipping” (excessive level) – reduce their gain to remedy this condition.

Operator's Guide

Clip LEDs – Above the two AUX gain controls, they light **red** when these channels are near clipping. To prevent audible distortion, reduce gain should you see them go red. If you still need more sound, turn up your power amplifier instead. As with the mic LEDs, these also light **yellow** for **prefade**.

Level Bargraph Display – Shows the program level. Its first **yellow** LED indicates a level of **0 VU** – which is equal to **+4dBm** at the *VGM-1041*'s balanced output. Each LED above or below this point represents a change of approximately **4 dB** in output level.

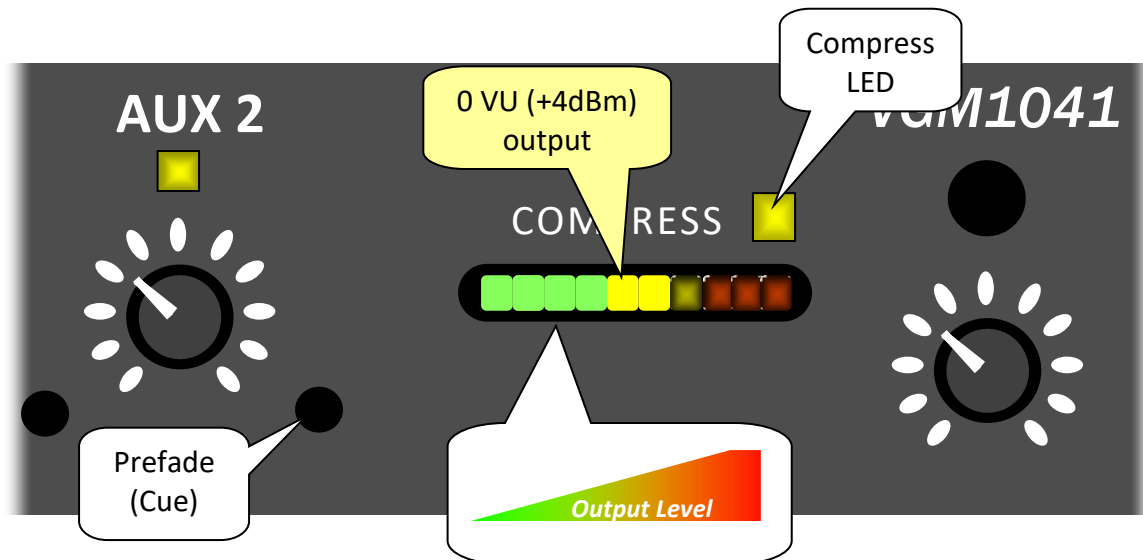

If your power amplifier's gain control has been set up according to the recommended procedure on page 20, a comfortable level for spoken material often reaches the first or second **yellow** LED. Dramatic or musical material can often be played louder, covering the entire **yellow** range into the first **red** LED. Use the meter as a guide – although your ears, and the audience response, are your best judgement of how much sound to provide.

Operator's Guide

COMPRESS LED – This LED displays the status of the mixer's compression system. It lights whenever compression is limiting the sound level. For each microphone channel with compression enabled, limiting begins to occur at approximately 0 VU. The **COMPRESS** LED shows **green** at **3dB** gain reduction, **yellow** at **6dB**, and **red** when compressing by **9dB**. Your mixer's DSPs perform compression independently on each enabled microphone while adding virtually no distortion.

To use the mixer's compressor, first make sure that compression is enabled on the desired mic inputs (see page 29). Then adjust each mic's level control until the **COMPRESS** LED blinks **green** and perhaps **yellow** on level "peaks". If totally dark, you may want to turn up that channel. On the other hand, if the **COMPRESS** LED illuminates **red**, the channel in use is set too high and constantly "hitting" the compression. In this case, reduce that mic level.

If you find that the **COMPRESS** LED remains dark for enabled mics in all conditions, or lights **red** even though the sound is barely adequate, adjust the volume of your power amplifier accordingly – you or your system installer should perform or repeat the procedure on Page 20.

Prefade bus and Headphone jack – Press any input's **PREFADE** button to place that input on the Prefade bus. Press it again to remove the input. The input's LED turns **yellow**, and the input can be heard at the Headphone jack, regardless of its Gain setting. When Prefade bus is in use, the Level Meter responds to the Prefade level instead of the main output level.

Operator's Guide

Managing Microphones – Your goal as sound operator is to provide sufficient, quality sound from all program participants to all in your audience. We've prepared this section to help you do this.

Your sound system allows participants to speak naturally or even softly as their material requires, confident that the audience hears every word clearly. To do this, the power of the sound coming from the loudspeakers greatly exceeds that picked up by the microphones. However, this advantage is also a liability: When one or more microphones receive enough of their own amplified sound from the auditorium loudspeakers, the result is that familiar "howl" often called, "feedback". Strictly speaking, a measure of feedback occurs even when not enough for a full-blown "howl". Lesser amounts of feedback can result in a hollow sound, as if your participants were speaking into an oil drum. Pros call this effect, *ringing*. Your audience finds this effect distracting and tiresome.

If you turn your mics down to zero, you guarantee no feedback and no ringing – but no benefit as well. As you increase your mic controls, the audience gets to hear more of the program, as amplified sound overcomes background noises. The sound becomes louder than your participants could provide alone – your system is producing "gain." In fact, the expression, "raising the gain" simply means turning up your mic controls.

This graph shows that as you turn up the mics, the desired sound (blue line) steadily increases, and the audience hears better. At first, the bad effects of feedback (red) are minimal. Increase gain beyond a certain point, however, and feedback multiplies. Once ringing is heard, you must *reduce* gain to achieve clear, usable sound. The dotted lines show when gain is set properly – enough sound while feedback remains inaudible.

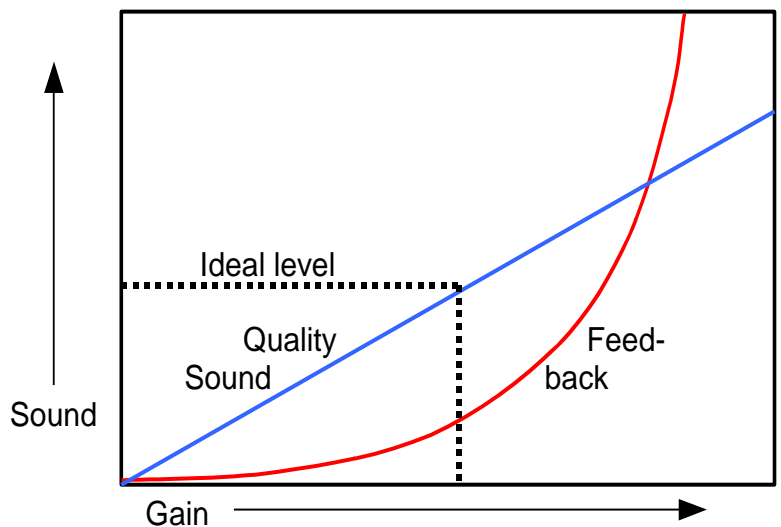

Operator's Guide

Ideally, your sound system, room acoustics, and the way mics are used, all allow you to provide plenty of sound without ringing. Extra available gain is logically called, *gain before feedback*. Having extra gain before feedback insures that you won't have to compromise between quantity and quality of sound. Your audience will benefit, and all will appreciate the results. If you find it hard to make your sound loud enough without ringing, you need more gain before feedback. Here's some ways to get it:

- **Train participants and stage handlers** so that everyone speaks **4"- 6"** from their microphones. Aim boom mics so they point toward the speaker's chin *when the speaker is looking straight out at the audience*. Proper miking lets everyone be heard with lower gain, resulting in sufficient sound without feedback problems.
- The *VGM-1041's* **sound gating** automatically increases your available gain before feedback, by muting unused microphones. Unneeded mics receive no useful sound – only feedback and noise. You win about 30% more gain before feedback for each mic gated off.
- **Don't use excessive compression**. If any mic input is causing the **COMPRESS** LED to glow **red**, lower that input's control. Compression actually *reduces* gain before feedback by encouraging more gain with quieter inputs – so allow the compressor to activate only for unusually loud sounds.
- Anything you can do to provide a **quiet auditorium** directly adds to your available gain before feedback. For example, keep auditorium doors closed during the program, to deflect lobby noise. If your hall's HVAC system makes excessive noise, see if anything can be done to quiet it.
- Additional improvements may involve management decisions, such as microphone choices (using microphones with a super-cardioid pickup pattern). Also consider room acoustics, especially in the stage area. Imagine, for a moment, your main stage mic spraying paint on the backstage wall – wherever the paint hits should be acoustically "dead" or damped. Unfortunately, decisions affecting room acoustics are rarely within the purview of those who know sound!

Operator's Guide

Thanks to the sound gating feature, there's far less need for you to turn mics up and down during the program. We still recommend, however, turning down mics that are obviously finding only noise:

- **Mics being moved** by stage handlers
- Certain wireless receivers that pick-up **radio noise** when their mics are turned OFF – turn up wireless mics only after they've been switched ON.

In short, working this mixer is like driving with basic cruise control – it makes your job easier, but you still have to drive. Here's some "safety tips."

- **When you hear ringing**, reduce gain on the affected mic(s). You'll know which mics are causing ringing by watching the mixer's **GATE** LEDs while listening for the ringing. Mics gated "off" cannot contribute to ringing at that moment.
- The **COMPRESS** LED may glow **green** or perhaps **yellow** momentarily at "high points" in the material. That's good – it indicates you're providing maximum usable sound.
- **When accidents happen** – a dropped mic, a cough, or a feedback howl – the mixer limits these nasty sounds (the **COMPRESS** LED lights **red**).
- If the **COMPRESS** LED lights **red** for normal material, your mic gain(s) are set too high! Turn them down until the mixer indicates only a slight, intermittent compression. You'll get clearer, more natural sound and less feedback. If you find yourself frequently needing more volume this way, slightly increase your power amplifier's gain setting. You and/or your system installer may wish to repeat the procedure on Page 20.

Operator's Guide

How Sound Gating Works

The *VGM-1041*'s digital signal processors arrive at each channel's level using a nonlinear, wave-sensing algorithm. Then the mixer's microcontroller monitors all these continuously, 6000 times per second. It "learns" the ambient sound at each mic to ignore background noise such as from air conditioning. Any mic whose level is at least 6dB louder than the others gates ON. Once live, a mic remains ON as long as **any** of these conditions are met:

- Its level remains higher than the threshold described above
- Less than 0.2 seconds "hang time" has elapsed since being above threshold
- It's the only live mic remaining (besides any **forced ON**, see page 30)

Microphone inputs gate OFF when **all** these conditions become false, remaining so until active again. Gating works best for orderly discussions – where generally, one person speaks at a time. The two dedicated Auxiliary inputs are not gated – thus they operate concurrently along with mics.

If the *VGM-1041* has not been set up properly at installation, you may find that the sound gating performs less than optimally. If for example the gating is **not sensitive enough** you may notice:

- Mics remaining dead for very soft speakers
- Missed syllables when someone begins speaking

In these cases, first be sure to turn each mic control sufficiently high. Mics that are turned down cannot gate ON or be heard!

On the other hand, you may find that the gate **too sensitive**, allowing mics to gate ON chaotically. Such operation renders the gating feature ineffective, reducing the available gain before feedback – thus, although this won't interfere with your program, you may wish to have the gating adjusted.

If the sound gating is not working properly, and handling your Gain controls appropriately doesn't help, ask your system installer about adjusting the power amplifier volume (page 20) and the gating (page 30). It's best if you can be present for these adjustments to ensure everyone's satisfaction.

Operator's Guide

Operation for Double-Hall Installations

When linking from the other auditorium is not desired, keep both **MIC9** and **MIC10** fully down, counterclockwise.

To listen to the program from the other auditorium, bring up **MIC9** to hear the microphones in the other auditorium. Bring up **MIC10** to listen to program material (music, etc.) from there. The second auditorium can have these controls up also -- thus allowing the program to originate from *either* hall while heard in *both* halls. The mixers interlock the signal paths involved to provide foolproof operation.

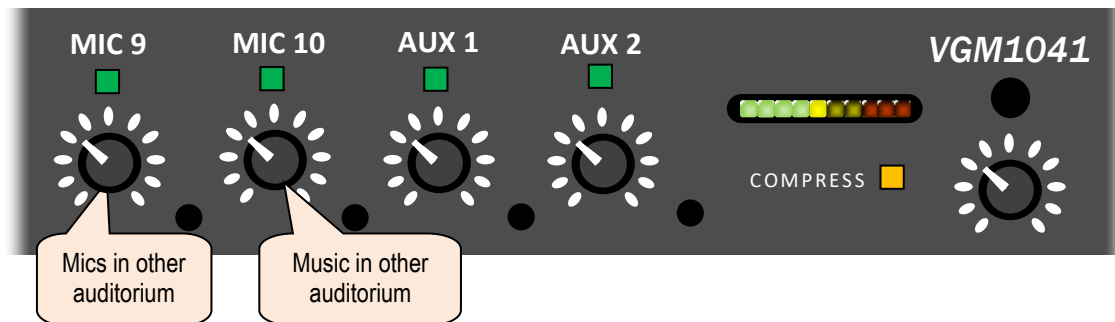

Operator's Guide

This Page Intentionally Left Blank
Don't you love it when they say that?

Installer's Guide

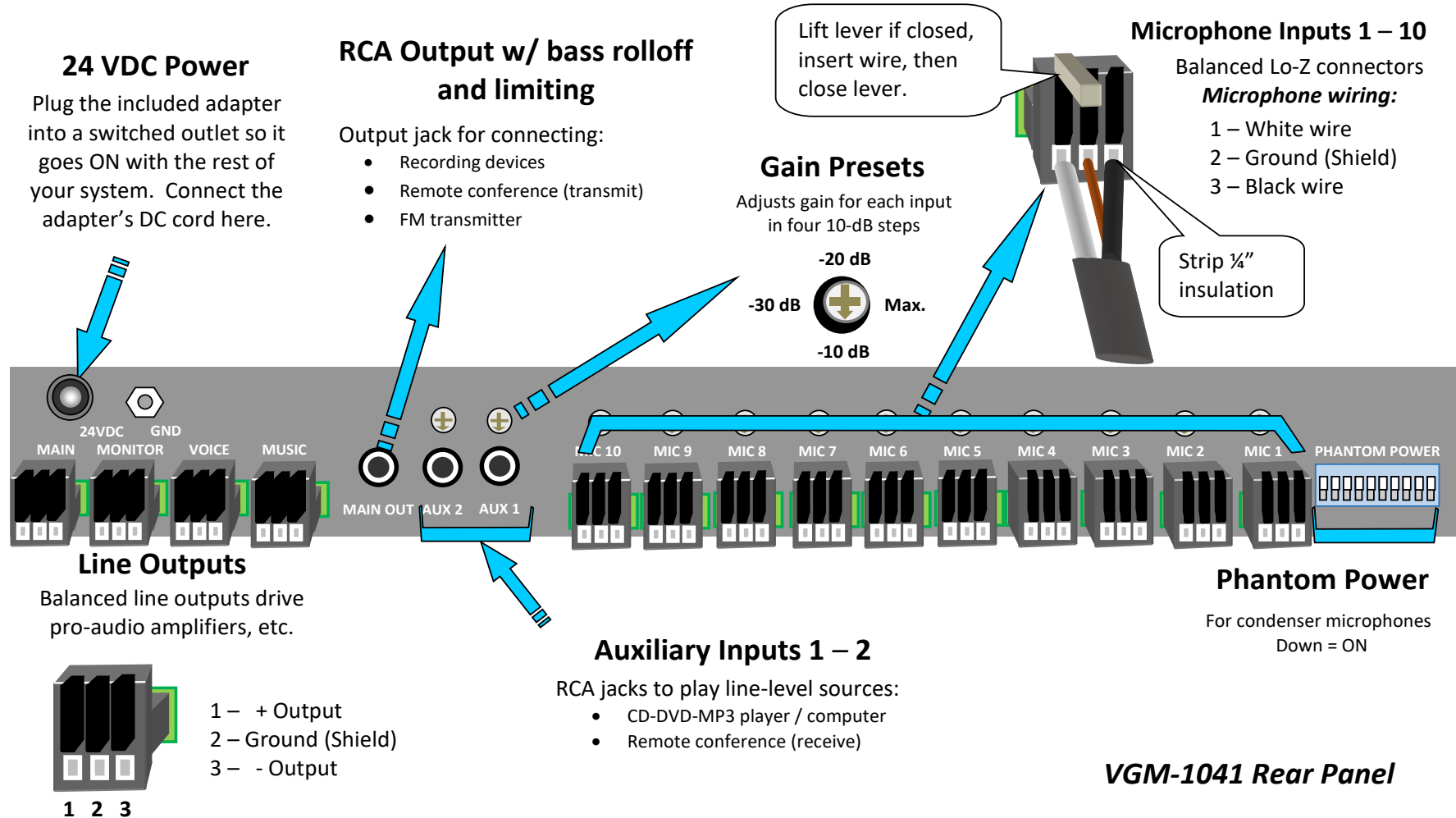

Installer's Guide

Channel "Personalities"

Recent updates to the *VGM-1041*'s firmware has added new features, including the ability to link two auditoriums together for overflow audiences. This has affected how microphone channels 9 and 10 work. When assigning MIC channels to your auditorium's microphones, this chart will help you make the best use of the mixer's capabilities. The following pages offer suggestions on mic channel assignments:



Purpose →		General wired & wireless microphone usage. Selectable main stage mic.	Mics / Double Hall		Music, etc.
F e a t u r e	De-Essing	Available	N/A		
	Link from Other Hall		Voice	Music	
	Input Type	Balanced, Mic-level inputs with available phantom power			RCA line level
	Voice Gating	Independent, adjustable gating at each mic			N/A
	Compression	Independent, selectable compression at each mic			N/A
	Stage Monitor	Selectable at any mic channel			Always on
	Music Path	Any Mic channel(s) can be moved to the Music Path			

Installer's Guide

Microphones, Cables, and Mounting

Arranging Microphone Inputs – The picture below illustrates a typical microphone arrangement. Here we show **MIC3** as your “main” or “chairperson’s” mic. Your mixer’s factory settings assume this -- however, you can easily select another input (see page 22).

You may of course have microphones at all 10 mic inputs. If your installation needs eight or fewer microphones, we suggest leaving **MIC9** and **MIC10** open for Double Hall Linking or extra Music inputs (see pages 31, 42). De-essing is not available at **MIC9** and **MIC10**.



Microphone Cables – Examine how your cables end at your sound rack. If they terminate as plain wires, simply connect them to the black tool-less plugs on the rear panel of your new mixer. For your convenience, these plugs are detachable – so you can wire them separately first. **To wire the connectors** – Strip approx. ¼” of insulation from the wires. Lift the locking levers if not already open, insert each wire into the plug’s opening, and then close each lever. If your mic cables are equipped with connectors, you’ve got a bit more work to do. You could cut off the connectors, then wire the cut ends as above. If you would prefer to keep the existing connectors, adapt them to the new plugs with short cables. For example, your present mic cables might terminate in A3M connectors. In this case – purchase some short (18”) cables with female connectors on both ends, cut them in half, and wire the cut ends to your new mixer’s tool-less plugs as above. This saves the trouble of soldering a bunch of A3F connectors. You can strain-relief these cables by tying them to the mixer’s GND lug with a cable tie – so their weight doesn’t hang on the connectors.

Mounting – The mixer fits into one space of a standard 19" rack. Be sure it’s accessible to the operator. Allow a blank rack space between the mixer and heat-generating equipment, such as power amplifiers.

Installer's Guide

Wireless mics – If possible, connect each wireless receiver's mic-level, balanced output to a microphone input of the mixer. This way, the mixer handles each wireless mic as it does other microphones, providing the gating and selectable compression features. Set any level controls on the wireless receivers, and/or the Gain Presets on the mixer's rear panel, to match their level to that of your wired microphones.

Condenser microphones – Condenser microphones feature excellent sound quality but require a power source to operate. Most expect to receive power from the mixer's microphone input (*phantom power*). Your mixer can provide phantom power at any or all microphone inputs. To select phantom power:

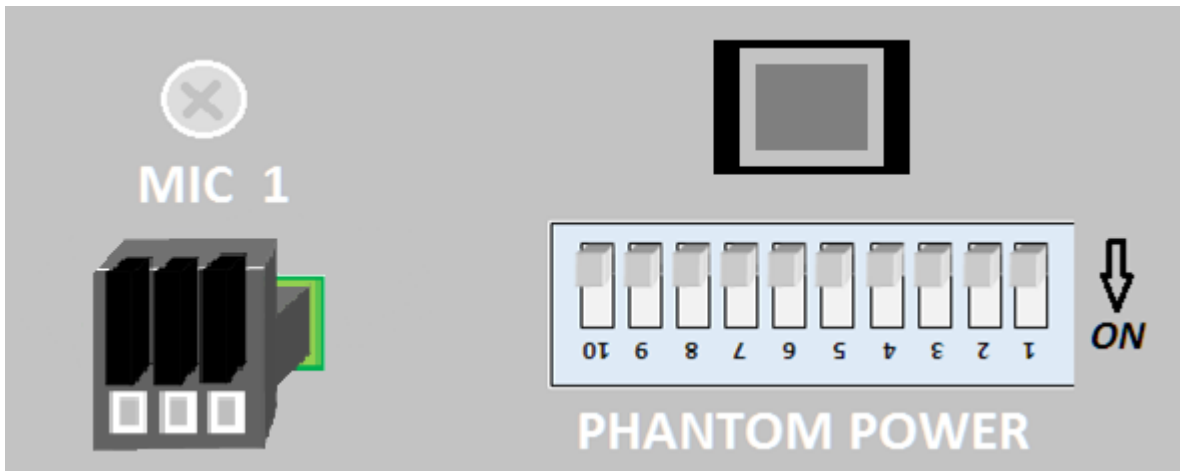

Move the switch corresponding to the condenser mic's channel to the **ON** position as shown. If condenser mics get moved among several channels, set **all** their switches to **ON**. Mics that use phantom power won't work without it. Dynamic microphones don't need phantom power, but usually tolerate it. Switch Phantom Power **OFF** for wireless receivers unless their instructions direct otherwise.

Input Gain – Each input's **gain** (amplifying ability) can be set to better match levels of different mics. A rotary switch above each input connector adjusts that input's gain in four 10dB choices. Adjust if needed with a small screwdriver. Generally, condenser mics are "hot" and can use a lower gain setting. Dynamic mics, especially older ones, need more gain. We suggest adjusting each input's gain preset so that you get a satisfying volume with its front panel control between half and 2/3 up.

Stereo Sources – Use a "Y" adapter to combine the *Left* and *Right* channel of stereo sources. Connect the resulting mono output to one of the two auxiliary inputs at the mixer.

Multiple sources – If you have more than two auxiliary sources, **do not** combine them with "Y" adapters as they may not perform properly. Instead, configure an unused mic input (such as **MIC 10**) as an extra music input – See page 31.

Installer's Guide

Line Outputs

This mixer features balanced line outputs for your sound reinforcement equipment. There's also an unbalanced, compressed RCA output for FM transmitters, recording devices, etc. The balanced outputs can provide a level in excess of +20dBm. Following equipment should be capable of a similar maximum level. When any equipment is driven beyond its maximum level, it "clips", flattening audio peaks – resulting in a characteristic distorted sound. You get the least noise from your equipment (best *signal-to-noise ratio*) when everything clips at the same level. Thus, it is best when following equipment can handle at least +20dBm.

Check the specifications of following gear. If necessary, you can reduce the mixer's output by loading it with a resistor as shown below. Wire this resistor into the connector at either end of the cable between the mixer's balanced output and the balanced input of the next device. The numbering at the amplifier input assumes the amp has a XLR input connector. Follow the amplifier's wiring instructions generally:

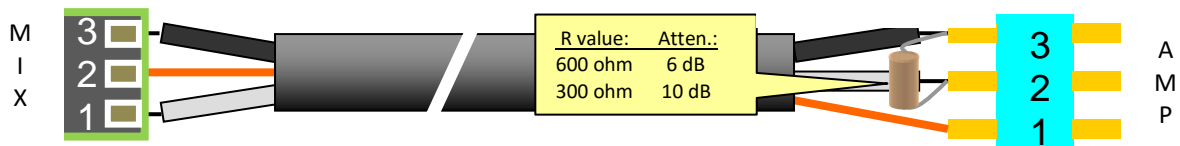

Four **balanced outputs** are available:

- **MAIN** – It provides the complete mixed and equalized output, normally connected to your system's power amplifier for auditorium listening.
- **MUSIC** – A separate mix of only music (the two aux inputs, plus any reconfigured mic inputs), without EQ.
- **VOICE** – A separate mix of only the remaining mic inputs – including the individual mic EQs but not the main voice equalizer.
- **MONITOR** – Includes the two aux channels, as well as any other channels selected at USB setup (see page 30). The factory setting excludes **MIC 3** and includes everything else.

The **Compressed MAIN RCA** output:

- This output provides the MAIN program (the complete mixed and equalized output). It features full-time 120 Hz highpass and dynamic limiting to optimize level for recording devices, FM transmitters for hearing impaired, and similar uses. We do not recommend driving your auditorium power amplifier with this output. This processing is separate and in addition to the selectable compression on each microphone.

Installer's Guide

Adjusting your Power Amplifier Gain

Because the VGM-1041 can be set to compress excessively loud sounds to a consistent level, *you need to adjust the rest of your system (power amplifier, etc.) to spot the corresponding auditorium volume as required.* This is easy to do if you follow the procedure below. In fact, we recommend following the procedure given below to get your levels “in the ballpark” whether or not you plan on using compression in normal operation. The mixer's Auto-EQ function (page 38) also depends on having the power amplifier's gain adjusted properly.

- Start with your power amplifier's volume control at a low level.
- If your system has an *external* equalizer, set it to *Bypass* or *Flat* mode.
- Have someone speak (reading a book works well) into a microphone connected to any channel that has compression ON (with the factory default setting, use any input **except MIC3**).
- Increase this mic channel's gain control until you see the **COMPRESS** LED glow **yellow** and **red** with the speaker's voice. At this point, the mixer output has reached its consistent compressed level. The level display should peak within its **yellow** range.

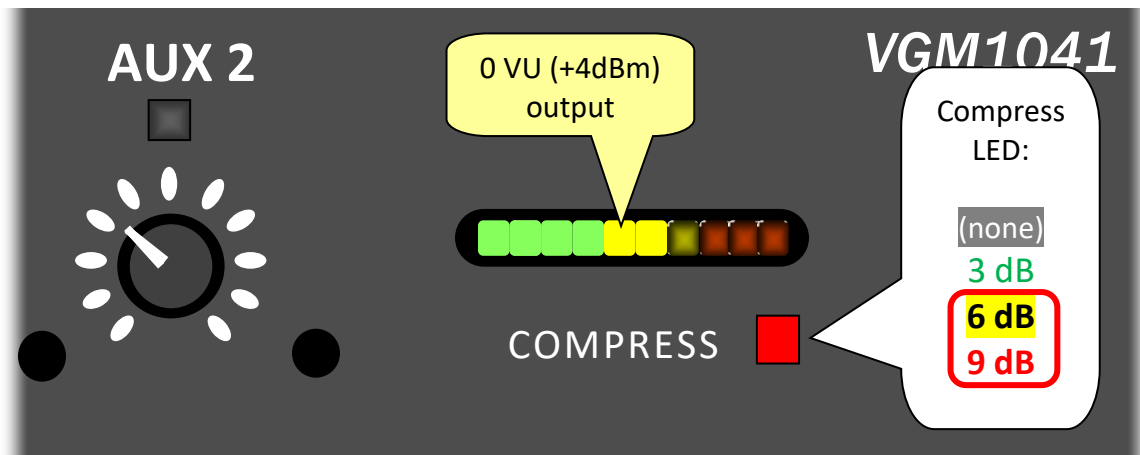

- Now, turn up your power amplifier's gain until your assistant's voice fills your auditorium to a fully satisfying, but still comfortable, listening level.
- Enable your external equalizer if equipped. The overall level shouldn't change much but adjust the EQ's gain control for approximately the same level.
- You may find that under actual use, when the auditorium is filled, slightly more volume is required. In that case, increase your power amplifier gain as needed.

Once you have found a good setting for your power amplifier, it should need little further adjustment. Instead, use your mixer to manage the volume of all your sources. We suggest you write down or mark the proper positions of your EQ and amplifier controls for future reference. To prevent unauthorized adjustments, mount security covers over these panels. In many installations, you'll need ready access only to the mixer and your sound sources.

Installer's Guide

Completing your Installation

Make sure these are complete *before* performing any additional adjustments:

- **Mounting** the mixer in your rack or cabinet
- **Connecting** all **MIC** and **AUX** inputs
- **Connecting** the mixer's **DC power adapter**
- Activating **Phantom Power** for mics needing it
- **Connecting** the **MAIN** output to your power amplifier
- **Setting** each **INPUT GAIN** switch to accommodate each input's level
- **Adjusting your power amplifier's gain** for correct compression level (page 20)

Using this as a checklist, double-check that all the above items have been accomplished. At this point the mixer should be quite operable. *It is imperative* to complete these basic tasks before proceeding with the advanced adjustments to follow!

Adjustment Overview

First, set your mixer for your "main" mic choice (bottom of page 22). You can then set up remaining options by several different methods – they're listed below, from the easiest to the most versatile. It's OK to combine these methods – for example, leaving some settings **preset**, setting others via the **USB** port, and then running **Auto EQ**:

How:	What:	Why:	When:
Factory Preset (below)	All functions pre-set	Works out of the box	Default EQ is acceptable
Auto EQ (Page 38)	Voice EQ adjusts to your auditorium	Still easy setup with improved EQ	Recommended for most installations
USB Setup (Page 23 – 37)	Allows you to select & adjust all options	Handles specific installation needs	Best performance with a more involved setup

Factory Preset

Besides the switch settings for phantom power and input gain, your *VGM-1041* has many options you can choose via its USB port. These include adjustments for its built-in **parametric equalizer**, a **de-esser**, and a **pink noise source** for system tuning. You can also switch unused **MIC** inputs to the mixer's Music path for use with additional music sources. Later we'll describe connecting to this port and choosing the options.

With all the possible settings, it's good to know that you can always return to the way your mixer came from the factory. Here's how:

Installer's Guide

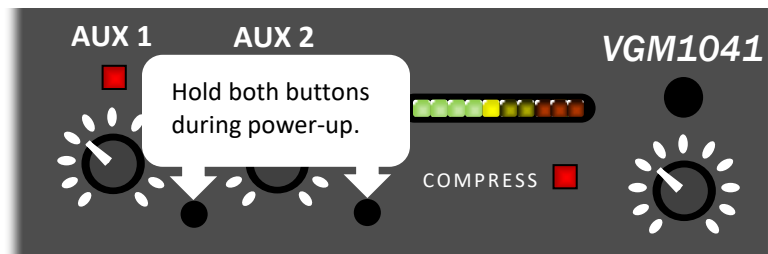

To **revert to factory presets**, *hold both* the **AUX1** and **AUX2 Prefade** buttons in while switching ON your system's power (including the *VGM-1041*). Continue holding until you see their LEDs blink in confirmation. This resets the following functions:

- **All mic channels** on the Voice sound path.
 - De-ess ON (mics 1-8), Double Hall ON (mics 9, 10).
- **MIC3** set as the **chairperson's** or **main** stage mic:
 - Compression and Stage Monitor OFF
 - Gate Threshold low
- **Other mic** channels set for general use:
 - Compression and Stage Monitor ON
 - Gate Threshold moderate
- **Equalization:** Individual mic EQs flat. Voice and Music EQ preset to improve typical auditorium sound "out of the box." Of course, you can alter these via USB; you can also automatically set the Voice EQ via Auto-EQ (see page 38).

Voice EQ:

Frequency	Bandwidth	Gain/Atten
141 Hz	1/3 octave	-6 dB
355 Hz	3/2 octave	-6 dB
1002 Hz	1/3 octave	-3 dB
1261 Hz	1/3 octave	-3 dB
1782 Hz	1/2 octave	-3 dB
4477 Hz	1/3 octave	-3 dB
7962 Hz	3/2 octave	+4 dB

Music EQ:

71 Hz	1 octave	+4 dB
316 Hz	2 octaves	-6 dB
7962 Hz	3/2 octave	+4 dB

Choosing a different "main" mic channel

If your "main" or "chairperson's" stage microphone is on a channel other than **MIC3**, set your mixer accordingly by holding down its **Prefade** button while powering up your system. Continue holding until its LED blinks. The mixer saves your choice until you change it again or do a factory reset (above).

Installer's Guide

USB Adjustments and Settings

Before making any of these adjustments, be sure your mixer has been properly installed in your sound system, with all the steps listed in **Completing Your Installation** (page 21) done.

With the mixer installed and rear panel switch settings properly made, the mixer's USB port can now be used to make advanced settings. These direct the mixer's six DSPs (Digital Signal Processors) to modify the sound accordingly. You can make any adjustment listed below:

- A separate two-band parametric EQ for *each* mic input to compensate for different microphone characteristics if needed
- Any mic input can route to the Music path for use with additional music sources
- A seven-band parametric EQ for the Voice mix, to adjust the overall response including speakers and room acoustics
- A three-band parametric EQ for the Music path
- Compression ON-OFF at each microphone input
- De-ess ON-OFF for each pair of microphones (mics **1-2, 3-4, 5-6, 7-8**)
- Double-Hall Mix-Minus using mic channels 9, 10
- Stage Monitor bus ON-OFF for each mic input

In addition, a Pink Noise generator is available while the USB is in use, to help you set up your EQs.

To make these settings, you need a computer with a "TTY" terminal program. The instructions that follow assume you're using a Windows computer or laptop, although terminal programs are also available for Mac and Linux. For Windows, please perform these tasks in the order given. The necessary files are included on the flash drive in your package:

- Install the **FTDI USB Driver**
- Run **PuTTYtel** (an open-source terminal program)
- Connect your **VGM-1041** using a standard USB A-B cable (not included)
- Adjust **PuTTYtel's** port settings
- Make your desired audio adjustments

Install the **FTDI USB Driver**

- Find the **CDM21224_Setup.exe** program on the included flash drive.
- Copy it to your desktop or another handy location and double-click to run.
- Follow the on-screen directions.

Installer's Guide

Run *PuTTYtel*

Note – You may use a different terminal emulator should you desire.

- Find the ***PuTTYtel.exe*** program on the included flash drive.
- Copy it to your desktop or another handy location.
- Run the ***PuTTYtel.exe*** file (it needs no installation). Click through the usual warning:

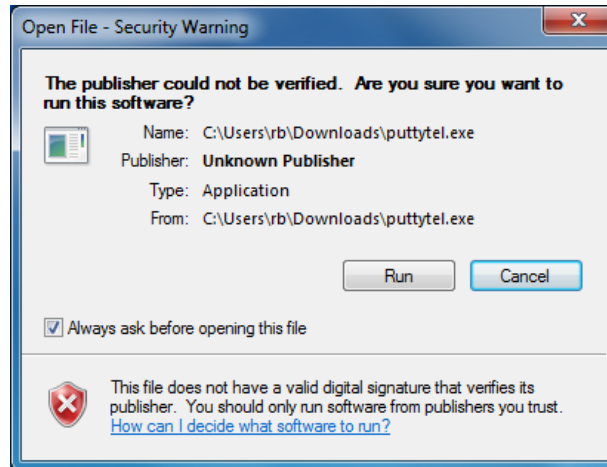

The PuTTYtel application opens, displaying its Configuration screen. Before doing anything there, proceed below to connect your *VGM-1041*.

Connecting your Mixer

- Attach a USB A-B cable (not included) to the mixer's rear panel jack
- Plug the other end into a free USB port on your computer
- Power ON the mixer (if not already on). You may see the usual ***Installing Driver*** message:

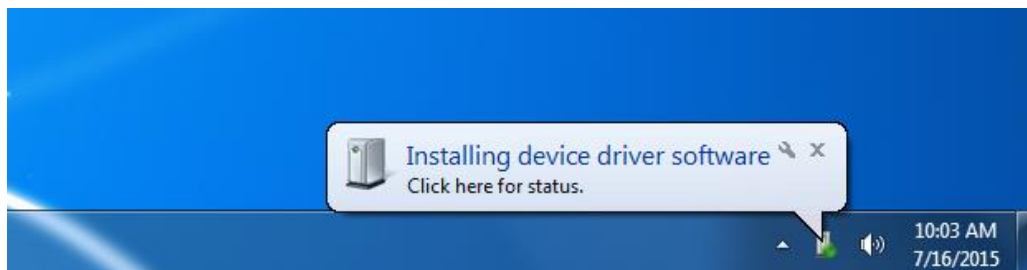

- **Restart** your computer if directed.

Installer's Guide

- Open **Device Manager** to find out what COM port your computer has assigned to the mixer. This is easier on some Windows versions than others:
 - Open your **Start Menu**, then type *Device Manager* in the **Search** box:

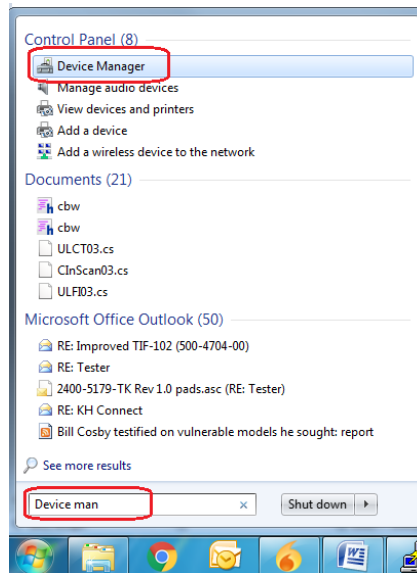

- **Or**, from your **Start Menu**, click **Computer**, then **System Properties**:

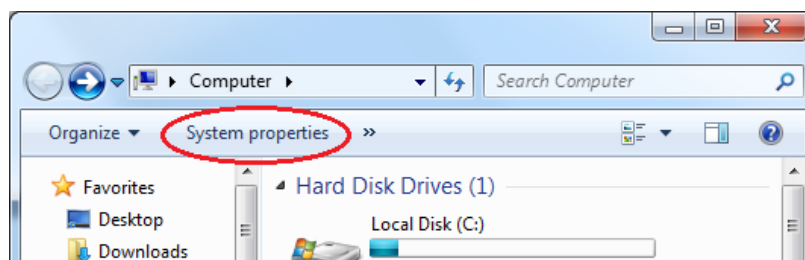

- Then, click **Device Manager**, which brings up the box shown next page:

Installer's Guide

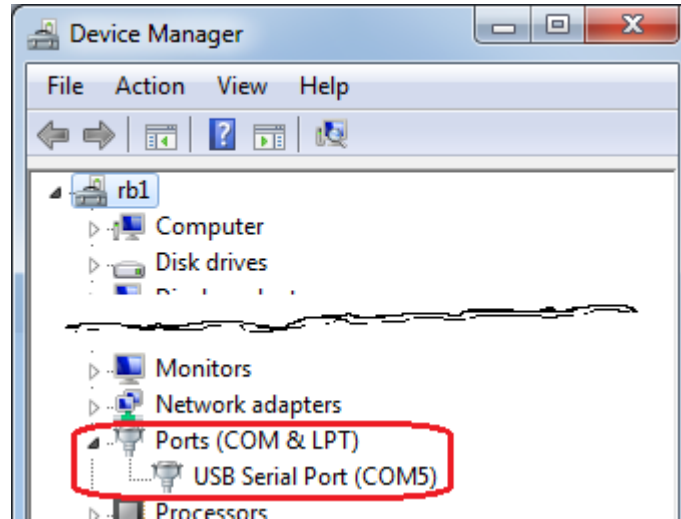

- In the resulting list, look for the number of the COM port that your computer has assigned to the VGM-1041's USB Serial Port (COM 5 in the example shown here).

If you don't see the USB Serial Port listed in *Device Manager*, its driver has not completely installed (this is possible even if you received the "Installing Device Driver Software" message). Here's how to correct this condition:

- In *Device Manager*, look for the heading, **Universal Serial Bus controllers**. Open this list, then *right-click* **USB Serial Converter** and choose **Uninstall** from its drop-down menu. Confirm this uninstall if asked.

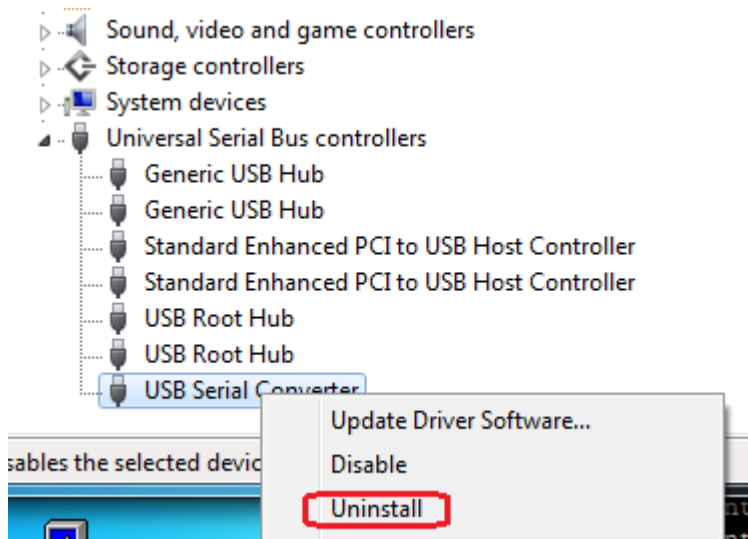

- **Unplug the VGM-1041** from the USB port. Wait five seconds, then plug it back in. This time, the driver should install correctly.
- **Tip** – Use the same USB port on your computer each time you connect the mixer.

Installer's Guide

Adjusting PuTTYtel's Settings

- Returning to PuTTYtel, first click the **Serial** choice. Then set the **Serial Line** box to the COM port found above, and the **Speed** box to **115200**. Finally, click the **Open** button.

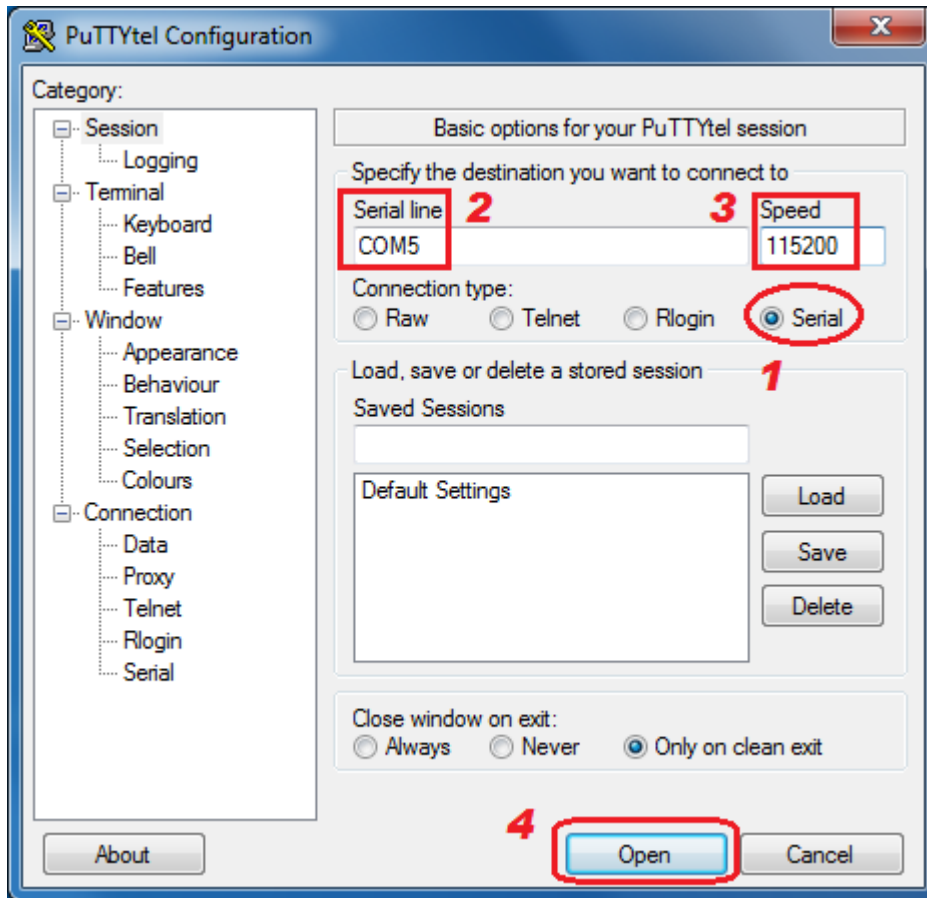

- **Press the space bar** on your keyboard – you should now see the mixer's filter-setting screen:

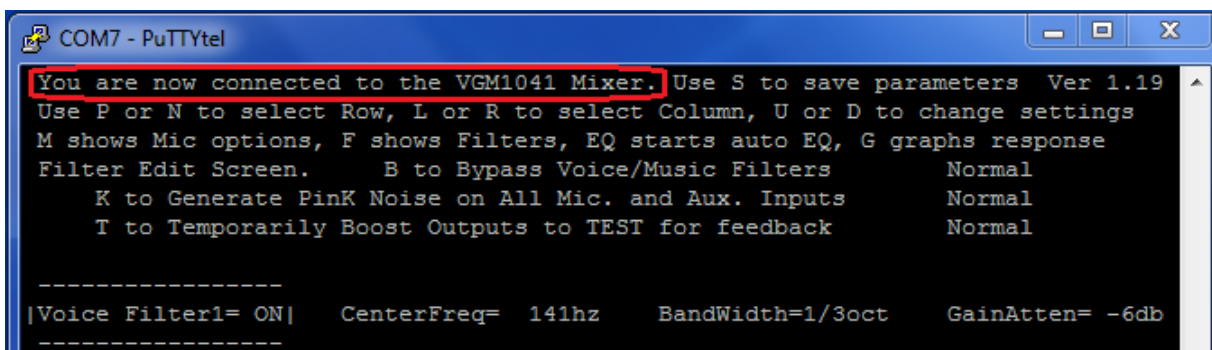

Installer's Guide

Moving Around the Screen

Edit the screen's settings **with your keyboard**, as described atop each screen. Your mouse, track pad, and touch screen *cannot* be used to make these settings:

```
You are now connected to the VGM1041 Mixer. Use S to save parameters Ver 1.19
Use P or N to select Row, L or R to select Column, U or D to change settings
M shows Mic options, F shows Filters, EQ starts auto EQ, G graphs response
Filter Edit Screen.      B to Bypass Voice/Music Filters      Normal
      K to Generate PinK Noise on All Mic. and Aux. Inputs      Normal
      T to Temporarily Boost Outputs to TEST for feedback      Normal
```

- *Navigation Keys:* Previous, Next, Left, Right – Or use your keyboard's **arrow** keys.
- *Change Setting:* Up, Down

```
Voice Filter1=off  CenterFreq= 1002hz  BandWidth=1.0oct  GainAtten= 0db
Voice Filter2=off  CenterFreq= 1002hz  BandWidth=1.0oct  GainAtten= 0db
Voice Filter3=off  CenterFreq= 1002hz  BandWidth=1.0oct  GainAtten= 0db
-----
Voice Filter4=off  CenterFreq= 1002hz  BandWidth=1.0oct  GainAtten= 0db
Voice Filter5=off  CenterFreq= 1002hz  BandWidth=1.0oct  GainAtten= 0db
Voice Filter6=off  CenterFreq= 1002hz  BandWidth=1.0oct  GainAtten= 0db
Voice Filter7=off  CenterFreq= 1002hz  BandWidth=1.0oct  GainAtten= 0db
Music Filter1= ON  CenterFreq= 200hz    BandWidth=1.0oct  GainAtten=-15db
Music Filter2= ON  CenterFreq= 44.8hz   BandWidth=3/4oct  GainAtten=+10db
```



- *Hotkeys:*
 - **Bypass** – Bypass all filters (press again to restore filters)
 - **pinK** – Toggle pink noise ON/OFF
 - **Test** – Increase gain by 10 dB (to test for feedback), press again for normal
 - **Mic** – Switch to the **Microphone** settings screen
 - **Filter** – Switch back to the **Filter** screen
 - **Save** – Save present *settings* (not hotkey options) to nonvolatile memory
 - **EQ** – Starts or aborts the Auto-EQ Setup algorithm (page 38)
 - **Graph** – Graphs the selected filters' frequency response (page 40)

You can **save** your settings at any time. Saved settings automatically load at power-up, so no computer is required to run sound. Settings remain stored until you change them again.

Installer's Guide

The Microphone Options Screen

Press the **M** key to enter the **Microphone Screen**. Here you can set the options described below:

```
You are now connected to the VGM1041 Mixer. Use S to save parameters Ver 1.19
Use P or N to select Row, L or R to select Column, U or D to change settings
M shows Mic options, F shows Filters, EQ starts auto EQ, G graphs response

Microphone Options, Stage Monitor, Compression, De-Ess, Base Gate Threshold
-----A-----B-----C-----D
Microphone 01 |Monitor= ON| Compress= ON De-Ess= ON Base Threshold=08
-----
Microphone 02 Monitor= ON Compress= ON De-Ess= ON Base Threshold=08
Microphone 03 Monitor=off Compress=off De-Ess= ON Base Threshold=04
Microphone 04 Monitor= ON Compress= ON De-Ess= ON Base Threshold=08
Microphone 05 Monitor= ON Compress= ON De-Ess= ON Base Threshold=08
Microphone 06 Monitor= ON Compress= ON De-Ess= ON Base Threshold=08
Microphone 07 Monitor= ON Compress= ON De-Ess= ON Base Threshold=08
Microphone 08 Monitor= ON Compress= ON De-Ess= ON Base Threshold=08
Microphone 09 Monitor= ON Compress= ON De-Ess= ON Base Threshold=08
Microphone 10 Monitor= ON Compress= ON De-Ess= ON Base Threshold=08
```

- A. Stage Monitor** – ON means that this channel is routed to the *VGM-1041's* separate *Stage Monitor* output. If desired, connect this output to an amplifier and speaker(s) audible at your auditorium stage. Its purpose is to help on-stage participants hear the sound from any mics located off-stage. Thus, to prevent feedback – turn OFF the Stage Monitor option for all mics used nearby.
- B. Compression** – Turn ON for most mic uses. An exception is the “main” or “chairperson’s” mic, which is often used when calling a noisy meeting to order. Compression would defeat this purpose, so choose OFF for this mic.
- C. De-Ess** – Spoken sibilance – “Esses” and “Tees” – can become painfully loud, especially if you provide plenty of treble response for the best speech intelligibility (which we recommend). The *VGM-1041* features an advanced DSP de-essing algorithm which regulates the *ratio* of sibilance to voiced speech. It “smoothes” speech with virtually no side effects. In other words, you won’t hear the de-esser – you’ll only hear the difference! However, should you wish to switch de-ess OFF, you can do it here. Four separate de-essers reside within the *VGM-1041*, each handling a pair of mics – MICs 1 and 2, 3 and 4, 5 & 6, 7 & 8. Thus, you can select de-ess ON or OFF for each pair.
- D. Base Gate Threshold** – Adjusts gating for best performance, also allows **force ON** and **Music path** options for each channel. Please see the next two pages.

Installer's Guide

Optimizing the Sound Gating

Follow these instructions if you need to adjust your mixer's sound gating:

First, be sure that your sound system's audio levels are set up properly. When your mixer is working near its design level, its microcontroller receives detailed information on mic usage, thus can make better gating decisions. Use your level display to verify this:

- Have an assistant speak or read into a mic while you slowly advance its control.
- As you turn up the mic, listen to the sound in your auditorium while observing the bargraph. The display should reach 1 - 2 **yellow** LEDs when your sound has found its comfortable, customary level (if compression is enabled on this mic, you'll also see the **COMPRESS** LED illuminate). If not, repeat the adjustment procedure on page 20.

Next, observe the sound gating performance using two or more mikes alternately. Note if gating is operating to your satisfaction. If not, you can fine-tune the mixer's decision process by adjusting each mic's **Base Threshold** number on the MIC screen

```
You are now connected to the VGM1041 Mixer. Use S to save parameters
Use P/N to select Row, L/R to select Column, U/D to change settings
Use M to select Microphone Options          F to select Filters

Microphone Options, Stage Monitor, Compression, De-Ess, Base Gate Threshold

-----
Microphone 01 |Monitor= ON| Compress= ON  De-Ess= ON  Base Threshold=08
-----
Microphone 02  Monitor= ON  Compress= ON  De-Ess= ON  Base Threshold=08
Microphone 03  Monitor=off  Compress=off  De-Ess= ON  Base Threshold=04
Microphone 04  Monitor= ON  Compress= ON  De-Ess= ON  Base Threshold=08
Microphone 05  Monitor= ON  Compress= ON  De-Ess= ON  Base Threshold=08
```

- If any mic seem to gate ON too easily, increase its **Base Threshold**
- If a mic hesitates to gate ON – especially if you have increased its gating threshold – reduce it by decreasing the **Base Threshold**
- To **force** a mic channel ON (disable gating), set its **Base Threshold** to **one (1)**. The channel replaces its Base Threshold legend with a **Gate Always ON** indication.

```
-----
Microphone 01  Monitor= ON  Compress= ON  De-Ess= ON  |Gate Always On 01|
-----
Microphone 02  Monitor= ON  Compress= ON  De-Ess= ON  Base Threshold=08
Microphone 03  Monitor=off  Compress=off  De-Ess= ON  Base Threshold=04
```

The **Base Threshold** affects gating results especially when room sound is relatively quiet. Once set properly in quiet surroundings, gating automatically adjusts for noisier conditions. The mixer's algorithm comes to *learn* the steady background noise at each mic's location – minimizing the influence of a nearby air vent or similar noise sources.

Installer's Guide

Converting MIC Inputs to use with Music Sources

If you have more than two music sources, you can press any of the mic channels into service to use with music inputs. Physically, these repurposed inputs remain mic-level, balanced inputs with tool-less connectors. There's several ways to adapt line-level sources to these inputs:

- Use a **direct box** (DI Box) to connect your line-level source to the mic channel. This is the best and easiest method. Follow the instructions which accompany your box.
- Build a simple attenuator with resistors – recommended if your high-level source is balanced. An arrangement like this shown below may be suitable:

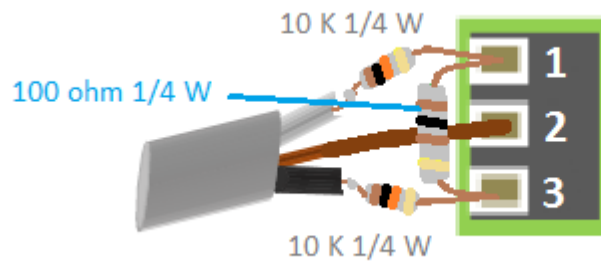

- **Switch Phantom Power OFF** for this input (unless your DI box calls for it) – page 18.
- Remember you can also use the input's rear-panel gain preset to accommodate your input, although this alone won't cover line-level inputs.

Once you have your source satisfactorily connected to an extra MIC input, the *VGM-1041* takes care of the rest. Set the chosen MIC channel's **Base Threshold** at **zero (0)** to route it through the Music path. The screen now reads "AUX Input" for this channel:

Aux input	01	Monitor= ON	Compress= ON	De-Ess=off	Gate Always On 00
Microphone	02	Monitor= ON	Compress= ON	De-Ess= ON	Gate Always On 01
Microphone	03	Monitor= ON	Compress= ON	De-Ess= ON	Gate Always On 01

Selecting this option activates these "Music" functions for this channel:

- The channel appears at the **Music** output as well as the **Main** outputs
- Its sound is routed through the **Music EQ** instead of the **Voice EQ**
- **Gating** is Always On.
- **De-Ess** and the 120 Hz highpass **anti-pop filter** are bypassed.
- The following "mic" features *remain available* – unique to these converted channels:
 - Selectable **Compression**
 - **Individual** channel **parametric EQ**
 - **Stage Monitor** is selectable instead of always ON.

Installer's Guide

Equalizer Filter Settings

Press **F** to enter the **Filter** screen. Each **parametric equalizer** filter allows setting its:

- **Center Frequency** – from 20 Hz to 20 KHz in 1/6 Octave steps (many more than shown below)

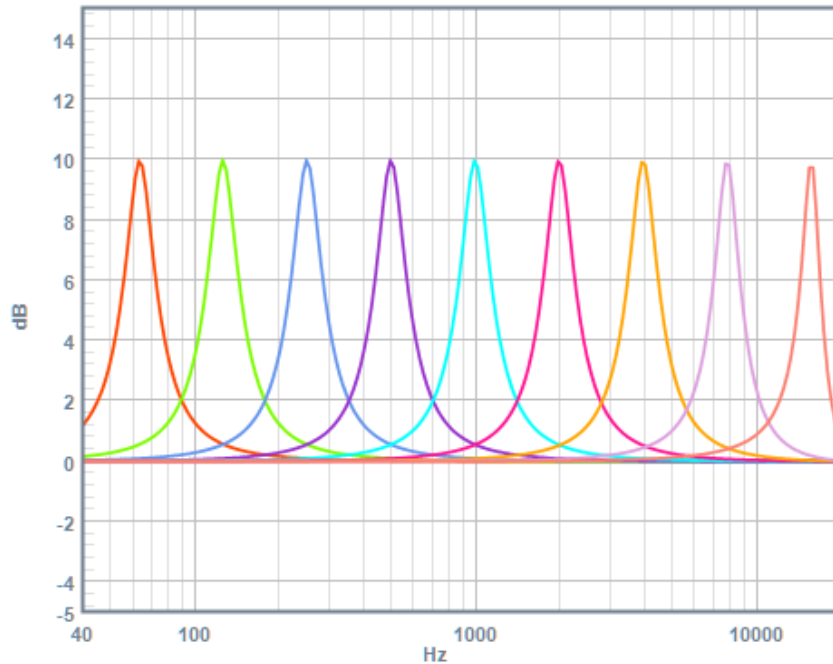

- **Bandwidth** – from 1/6 Octave to 3 Octaves in nine steps

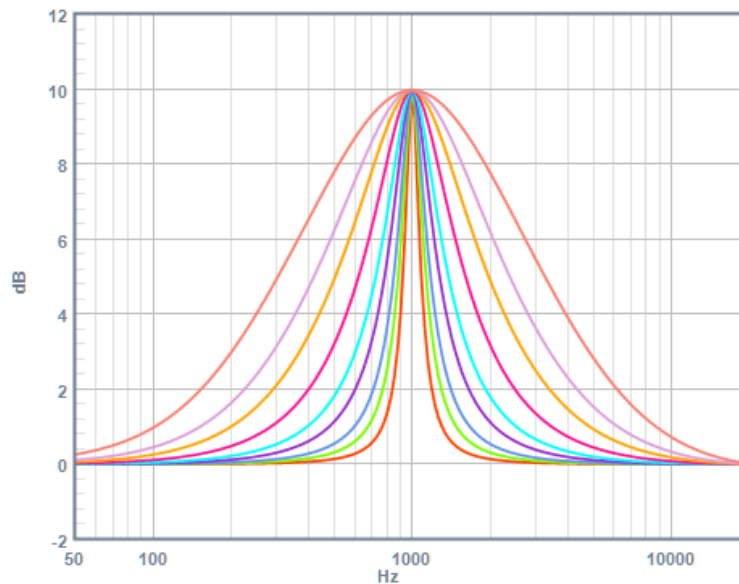

Installer's Guide

Gain / Attenuation – from -20 dB to +10 dB in 1 dB steps
(-9dB to +9dB is shown below):

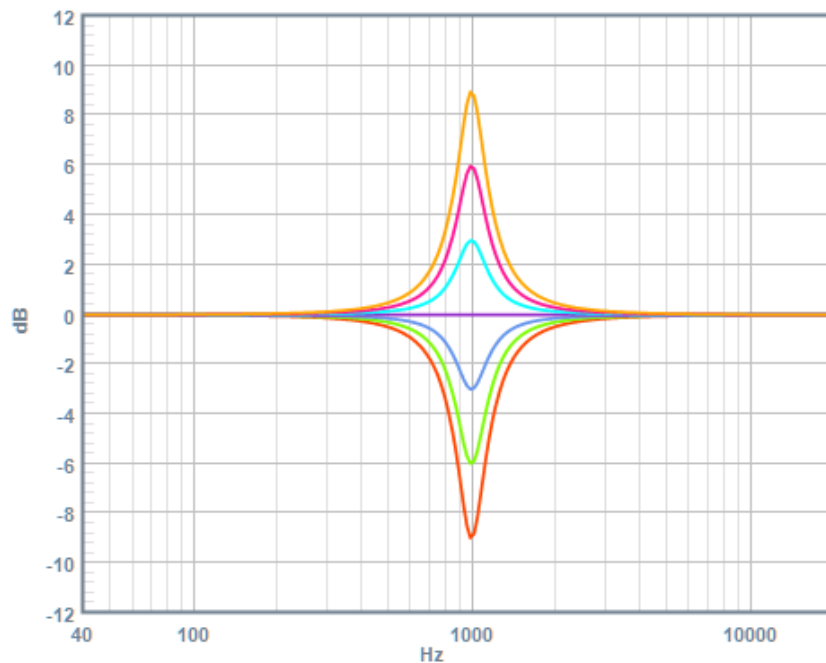

What a Parametric Equalizer Does

All the mixer's EQ filters are **parametric**. This section introduces **parametric filters** for those unfamiliar with them. We'll begin with the familiar *graphic equalizer* often found in home stereo systems and MP3 players. A typical one is pictured below:

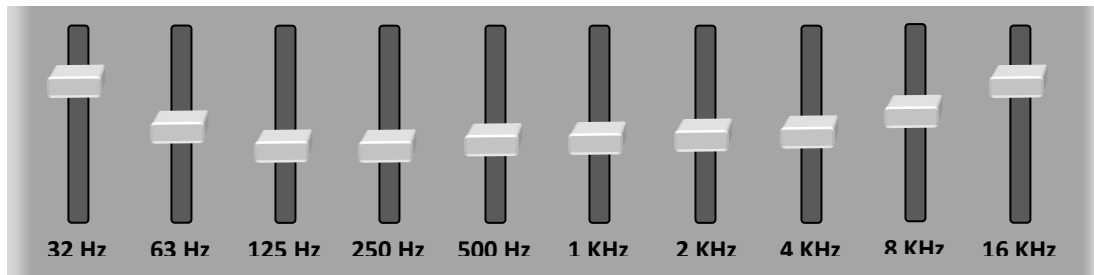

You can adjust how this equalizer handles ten distinct frequency bands as labeled. When set as shown here, this sort of equalizer might produce a frequency response curve like this:

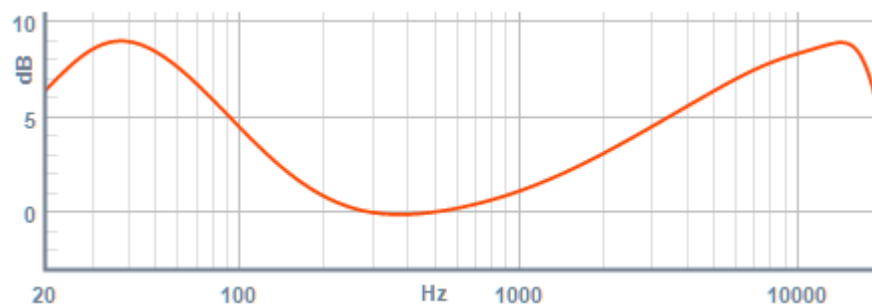

Installer's Guide

Notice how the response curve mimics the position of the sliders – it's a *graphic* EQ! With the graphic EQ you adjust *only* the gain or attenuation of each filter. Its other **parameters** – *center frequency* and *bandwidth* – are fixed by design. On the other hand, with a parametric EQ you can – guess what – adjust *all* these parameters. Often a parametric EQ has fewer filters compared to a typical graphic equalizer, yet you can do so much more with it. Below, the three Music filters have been set as shown:

Voice Filter6=off	CenterFreq= 1002hz	BandWidth=1.0oct	GainAtten= 0db
Voice Filter7=off	CenterFreq= 1002hz	BandWidth=1.0oct	GainAtten= 0db
Music Filter1= ON	CenterFreq= 200hz	BandWidth=1.0oct	GainAtten=-15db
Music Filter2= ON	CenterFreq= 44.8hz	BandWidth=3/4oct	GainAtten=+10db
Music Filter3= ON	CenterFreq=15886hz	BandWidth=3/2oct	GainAtten= +8db
Mic.1 Filter1=off	CenterFreq= 1002hz	BandWidth=1.0oct	GainAtten= 0db

The corresponding filter response curve appears below:

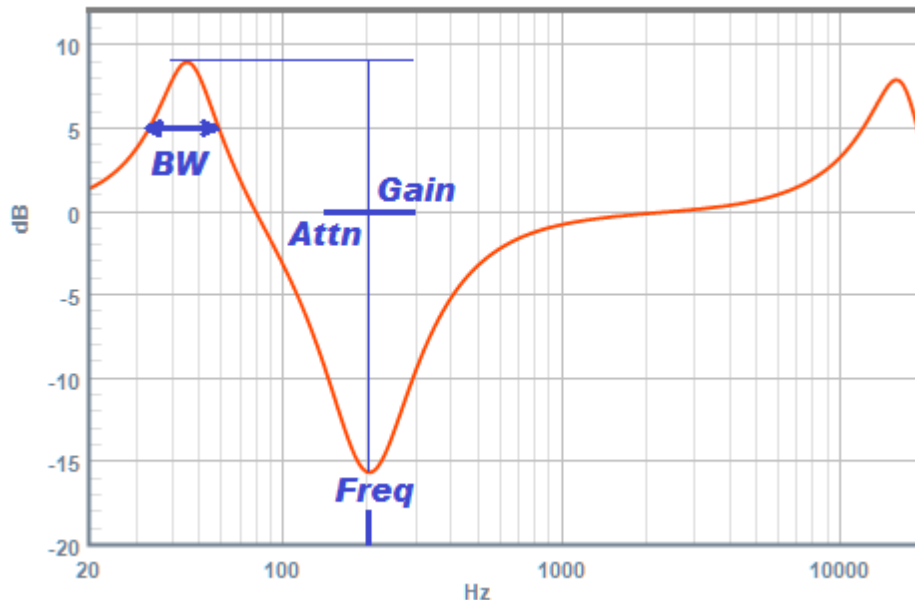

This filter curve appears extreme, yet it equalizes a cheap pair of computer speakers to produce decent sound. Of course, this only works within the sound system's limitations. Perhaps we would like our video presentations to shine with sparkling highs and "movie theatre" bass – but if your system cannot handle such performance, you may end up with screeches and rattles, respectively. Be creative but be careful! Generally: Sharp, low BW filters are often used to null out frequencies that tend toward acoustic feedback on mics. Smoother, high BW filters find use as "tone controls" for music playback.

Factory EQ settings

The factory settings described on Page 22 prevail should you choose not to make your own adjustments. These default settings are based upon experience with sound installations. Likely you'll notice much better sound than without any EQ. Certainly, however, you're free to choose your own settings, including no EQ (flat response).

Installer's Guide

Setting the Music EQ

With many “average” sound systems, a modest boost at around 70 Hz, a broad rise centered at perhaps 9 KHz, and some broad attenuation near 300 Hz may improve music reproduction. Experiment with various program material to find good settings.

Setting the Individual MIC EQs

Making use of each channel's MIC EQ is entirely optional – however, if you choose to use them, it's best to set them up *first* – before tuning the system with the Voice EQ. If all your mics are identical, you won't need the individual EQs. And if dissimilar mics are plugged randomly into assorted channels, you *can't* use them. However, suppose your wireless mics sound different from all the others. You can set their channel EQs to minimize this difference. For example, here's the published response for an *Electro Voice 767 / RE2* mic. The solid curve represents normal response; the dotted line is for close-range use. Since no one “eats the mic” in our example application, we can safely ignore the dotted line:

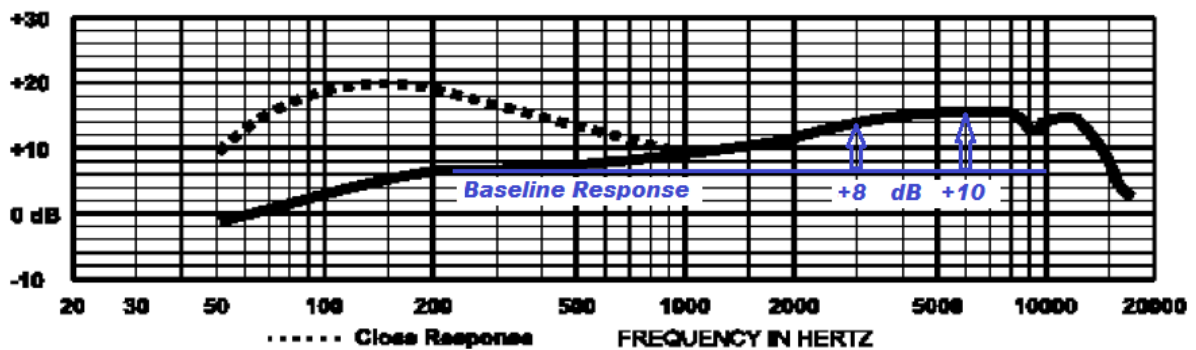

We're left with a response that broadly rises between 3 and 6 KHz. Let's assume that all other mics are either reasonably flat in response, or have already been compensated by their own channel EQs. Then, we might apply the EQ shown below for any channel(s) handling this model mic:

```
Music Filters= ON      CenterFreq=13886hz    BandWidth=3.72oct    GainAtten= +8db
Mic.1 Filter1= ON     CenterFreq= 3169hz   BandWidth=2.0oct    GainAtten= -4db
Mic.1 Filter2= ON     CenterFreq= 6324hz   BandWidth=2.0oct    GainAtten= -5db
-----
|Mic.2 Filter1= ON|   CenterFreq= 3169hz   BandWidth=2.0oct    GainAtten= -4db
-----
Mic.2 Filter2= ON     CenterFreq= 6324hz   BandWidth=2.0oct    GainAtten= -5db
Mic.3 Filter1=off     CenterFreq= 1002hz   BandWidth=1.0oct    GainAtten= 0db
```

Here we suggest that you be conservative and take a lesson from the compass adjusters of old – *only remove half* of the response error. Too much EQ can exaggerate problems as easily as fix them.

Installer's Guide

Set Up the Main Voice EQ

The VGM-1041's seven-band parametric **Main Voice EQ** is where you tune your entire sound system – residual mic responses, speakers, and room acoustics – to provide the best sound. Often, “best sound” means the most *gain before feedback*. The higher your operators can turn up a mic without problems, the easier it will be for them to give the audience the sound they deserve. Please see the *gain before feedback* discussion on pages 9 – 11. Typically, as a mic is turned up, overall response rises until its highest peak reaches the point where feedback becomes objectionable – it shows up first as *ringing* – an annoying echo at the problem frequency. Turning it even higher yields the familiar “howl”. If we adjust the EQ to attenuate sound at this peak, we get more room to turn up the mic – we achieved this much more gain before feedback. Thus, by leveling the peaks and valleys of your system's overall response, you'll also achieve the best gain before feedback.

By-Ear Method

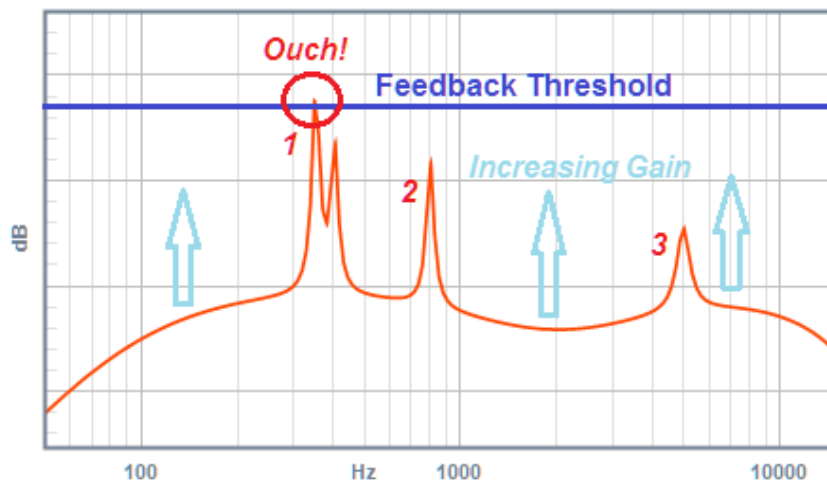

This method takes advantage of the effect described above to locate your response peaks. Basically, you increase a mic's gain until you begin to hear feedback. For example, it's evident that the peak (or *feedback node*) labeled **1** here, will sound off **first** as gain is increased.

We then tune one of the EQ filters to flatten the peak that caused this feedback. This allows you to turn up the mic further, in turn discovering the next feedback node. Continue this process until the system tends toward feedback at several competing feedback nodes – this indicates you've reached diminishing returns. Some helpful tips:

- **Perform this procedure on your “main” mic**, the one used the most.
- Temporarily **set this mic channel's options** (see pages 29 – 30):
 - **Disable gating**, switch **De-Ess OFF**, and **Compression ON**.
- **Station an assistant** at this mic as if using it. Often their very presence affects the mic's acoustics. Occasionally have them speak (reading a book works well).
- **Increase** the mic's control until you hear ringing. If you can't get feedback with the control advanced, use the **T** hotkey (see page 28) to obtain more gain.
- To **find** the feedback node **frequency**:
 - Set a filter for narrow bandwidth and about -6 dB gain, then use the **Up & Down** keys to **sweep the frequency** until the feedback goes away.
 - Or, use a Real-Time Analyzer (RTA) Smartphone app to identify the node.

Installer's Guide

Pink Noise Method

Pink noise sounds rather like a waterfall. It contains equal energy per octave, resulting in a flat response curve as measured with a **Real-Time Analyzer (RTA)**. Since the pink noise enters your sound system with its characteristic flat amplitude vs. frequency curve, any irregularities in your system and room show up in the actual sound you hear. We can analyze this response with a microphone and RTA.

- No need for a calibrated microphone, just use your main stage mic. This covers your entire reproduction chain, from mic to speakers to room. The least expensive RTA might be a USB audio interface connected to a computer or laptop running RTA software.
- The mixer's built-in *Pink Noise Gen* can supply pink noise to any one channel, so no external pink noise source is needed.

With your external equipment set up, you're ready to run a Pink Noise adjustment:

- Press **K** to toggle PinK Noise ON. Choose the input to play pink noise through (generally the channel supporting the most-used mic). Don't use a channel that has been converted to a Music input.
- Turn up **only** this control until you get a good level at the RTA.
 - Note: Differing filter settings among your channels may cause erroneous results when mixing several Pink Noise inputs.
- Temporarily set this mic channel's options (see pages 29 – 30):
 - **Disable gating**, switch **De-Ess OFF**, and **Compression ON**.
- On your RTA, note the frequency and height of the largest peak.
- Set a Voice Filter to its closest frequency. Experiment with this filter's gain and BW controls to minimize the peak.
- Locate the next peak on the RTA, and then assign another Voice filter to cancel it.
- Continue until the RTA curve is reasonably smooth. Attempting a perfectly flat response is unnecessary and perhaps undesirable.
- Return your mic to the stage and try it out with a helper speaking, as described in the **By-Ear** method above. Make any additional adjustments by ear.
- When all done, return this channel's settings to those desired for regular use.

We have found that combining the two methods – starting out with **Pink Noise** and ending with **By-Ear** adjustment – may yield better results than either method alone. You can also try the **Auto-EQ** method (next page). In any case, you need not fret excessively over these adjustments. If the sound system operates to your satisfaction, the equalization is good enough! We have also found that overzealous EQ adjustments tend to reduce the overall level, forcing operators to compensate by turning up mics – thus cancelling out the benefit.

Installer's Guide

Auto EQ Setup

This feature matches your mixer's Voice EQ to your prevailing sound system and room acoustics. It works much like the "By Ear" method described on Page 38, except the mixer "listens" and performs the EQ adjustments for you. Here's how to use it:

Preparation: Begin with your sound system operating normally:

- Everything under *Completing Your Installation* (page 21) has been done.
 - Especially your power amplifier's gain adjustment (page 20).
- Arrange for quiet conditions in an empty auditorium.
- Have a volunteer stand at your "main" mic as if using it (use any mic channel *except* **MIC9**, **MIC10**, or any converted to Music inputs).
- While they speak, turn up this input to get a satisfying level
- Have them stand there silently for the rest of this procedure.
- Turn all other **MIC** controls to zero.

Start the Auto-EQ Function:

- Switch your sound system (including the *VGM-1041*) OFF.
- Hold both **Prefade** buttons for **MIC9** and **MIC10**.
- Continue holding while switching the system back ON (wait for mixer to start up).



Hold buttons in while powering up.

Note: If using the USB control port, you can also activate Auto-EQ by pressing the hotkeys **E**, then, **Q**. You can cancel it anytime the same way.

Auto-EQ usually completes in two minutes or less. During this time, you'll hear feedback howls come and go at various levels and frequencies. This is how the mixer finds feedback nodes – it increases gain beyond normal to find a feedback howl. A built-in RTA function measures the howl's frequency. It then assigns one of the Voice EQ Filters to notch out this feedback node. This process repeats to find additional feedback nodes. When all the EQ filters have been assigned, it goes through the list attempting to consolidate neighboring-frequency or unneeded filters, making them available for further tuning. While Auto EQ is working, the *VGM-1041*'s LED bargraph displays the extra gain the mixer is applying to obtain feedback howls. This indication should show about halfway most of the time. Should you find it much above or below halfway, adjust your MIC channel's gain control slightly, leaving it alone afterward. It's normal for the LED display to advance one or two bars while the mixer continues to chase feedback nodes. This represents *more gain before feedback!*

Installer's Guide

Double Hall Installations

You can link the mixers in two auditoriums together to provide sound to an overflow audience. The linkage can be one-way or two-way, and for voice (mics), music (aux), or both. This feature makes use of MIC channels 9 & 10, making these unavailable for mics in a double-hall installation.

The double-hall installation requires running four shielded-pair cables between the mixers. The interconnections are shown below. Connect 10 ohm, half-watt resistors across the Voice and Music inputs as shown, and set the MIC9, MIC10 gain switches to -30 dB. Switch Phantom Power OFF for Mics 9 & 10 on both mixers:

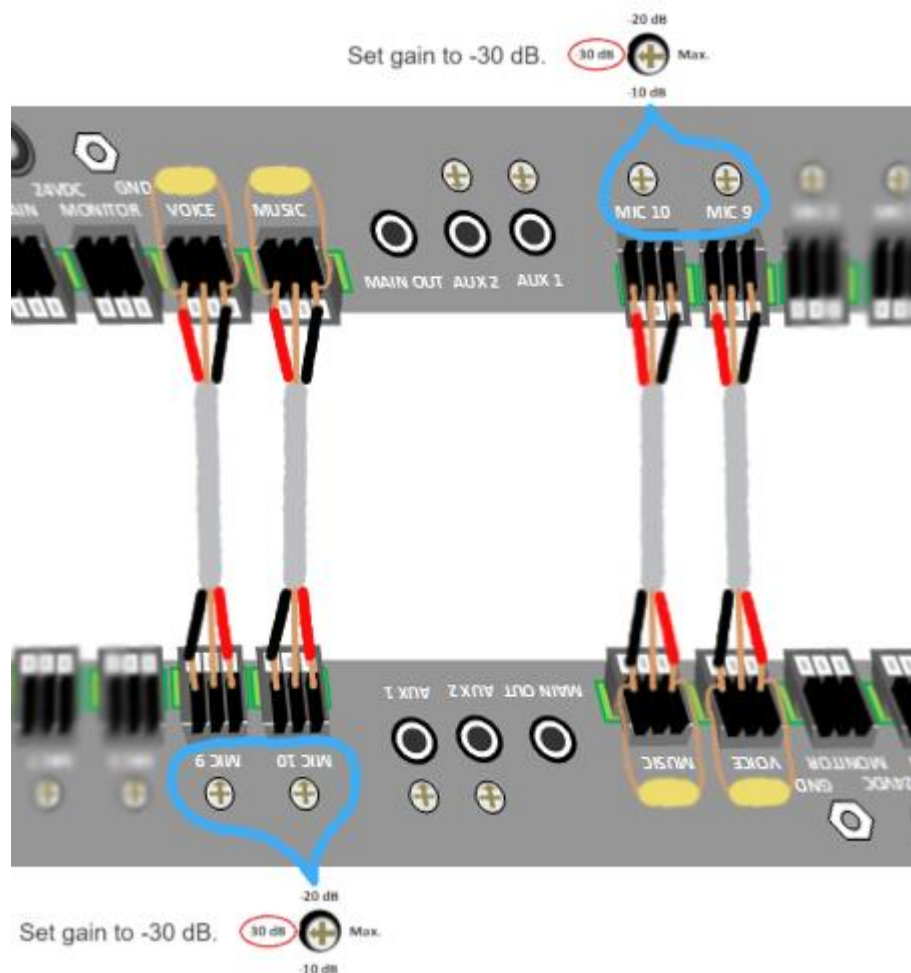

Be sure that the cables are connected exactly as shown – VOICE to MIC9, MUSIC to MIC10 on both mixers. Mixing these up may cause *electronic feedback* between the mixers. Unlike acoustic feedback which you're already familiar with, electronic feedback is where audio components are interconnected in a way that directly runs a signal output back to its input. The result produces powerful oscillations which may be extremely loud or even beyond hearing range, thus inaudible. These can damage equipment, so please double-check the wiring.

Installer's Guide

The recommended Mic Screen settings for use with a double-hall installation are shown below:

```
You are now connected to the VGML041 Mixer. Use S to save parameters Ver 2.04
Use P or N to select Row, L or R to select Column, U or D to change settings
M shows Mic options, F shows Filters, EQ starts auto EQ, G graphs response

Microphone Options, Stage Monitor, Compression, De-Ess, Base Gate Threshold

Microphone 01  Monitor= ON   Compress= ON   De-Ess= ON   Base Threshold=08
Microphone 02  Monitor= ON   Compress= ON   De-Ess= ON   Base Threshold=08
Microphone 03  Monitor=off   Compress=off   De-Ess= ON   Base Threshold=04
Microphone 04  Monitor= ON   Compress= ON   De-Ess= ON   Base Threshold=08
Microphone 05  Monitor= ON   Compress= ON   De-Ess= ON   Base Threshold=08
Microphone 06  Monitor= ON   Compress= ON   De-Ess= ON   Base Threshold=08
Microphone 07  Monitor= ON   Compress= ON   De-Ess= ON   Base Threshold=08
Microphone 08  Monitor= ON   Compress=off   De-Ess= ON   Base Threshold=08
-----
Microphone 09  |Monitor=off|   Compress=off   Mmlink= ON   Gate Always On 01
-----
Aux input 10   Monitor= ON   Compress=off   Mmlink= ON   Gate Always On 00
```

We recommend setting Mic 9's Stage Monitor **off** on both mixers, to help prevent *acoustic* feedback between both auditoriums.

In Case of Difficulty

Troubleshooting

When the sound system's down, one's first instinct is to panic! It's better, though, to *work the problem* and find out what's wrong:

Power / self-test – Is every power indicator light in your system illuminated? Someone may have inadvertently switched OFF a component (this is why the *VGM-1041* has no power switch!). To minimize power problems, we recommend installing a “master switch” for the entire sound system.

A functioning *VGM-1041* completes its self-test (the “light show”) when first powered up, after which at least one front panel LED remains lit at all times. If the “light show” becomes stuck, or the mixer appears dead though power is confirmed, it's likely defective. See *Support and Warranty*, next page.

Sources – Is part of your system working? Is the problem limited to one mic or one auxiliary source? Test the various sources to find out, perhaps with headphones plugged directly into your mixer. This will help you find out where the problem is – before, inside, or after your mixer. For video sources, make sure the video is streaming or playing properly.

Outputs – Do you have an FM transmitter or recording device connected to your mixer's output? If so, see if it works. If it does, this indicates that the problem is most likely *after* your mixer – for example, in the power amplifier or speaker wiring.

Level meter not responding – Is Prefade (yellow LED) activated on any input? Then the meter responds only to this input, ignoring the others.

Low volume – Mics turned down cannot be heard. Be sure that your mixer's controls are “up” on desired inputs. Verify that any level controls between the mixer and your loudspeakers (amplifier, effects boxes, etc.) are set to their normal positions. If the problem remains with one mic, increase the affected channel's gain preset (see Page 15). If low volume is accompanied by hum or buzz, check the mic cable(s).

“Dead” Mics – Mic inputs turned down won't gate ON, so check that all microphone inputs in use are turned up. Try the same mic with another input, and the affected input with another mic, to see where the problem moves. Condenser mics need phantom power (see page 18).

Excessive volume – Connect your auditorium power amplifier to your *VGM-1041*'s balanced MAIN output (not the other balanced outputs, and not the compressed RCA MAIN output). Use your power amplifier's line input (*not* its mic input!). Set its level or gain control according to the instructions on Page 20. If any source(s) seem excessively loud while their level control(s) remains at ¼ or less, reduce the gain preset(s) for the affected channel(s) – see Page 15.

In Case of Difficulty

Support & Warranty

We hope you won't need the following information, but please be assured that should your mixer malfunction, we're here to help. Of course, we do recommend reviewing the *Installation* and/or *Troubleshooting* sections of this manual before calling. Often an installation or operation issue is behind apparent defects. We also recommend that, if possible, the person most familiar with the problem phones from your site – where both your sound system and this manual are close at hand.

You may call ACI-AppliCAD at **(732) 751-2555** during normal business hours (Eastern Time) to get help with installing, using, or troubleshooting your mixer. If it appears that your mixer is defective, we'll issue a RMA (**R**eturn **M**aterial **A**uthorization) number for factory service. Your limited warranty is **one year** from date of purchase. Out of warranty, please contact Applied for current repair charges.

Please note that this product uses surface mount and digital technologies extensively. We don't recommend you attempt internal repairs yourself, even if you're comfortable around electronics. Firmware source code is not available to customers.



Whether your mixer is in or out of warranty, we strive to provide fast, courteous service. Like the *VGM-1041* itself, we are devoted to *solving problems* in sound reinforcement.

Specifications

Inputs & Outputs:

- 10 Mic inputs. Balanced, Low-Z, solderless, tool-less connectors
 - Individually selectable compression and 24V phantom power
 - Each configurable as an extra AUX (Music) input
- 2 AUX inputs. Unbalanced RCA
- 4 Balanced outputs: Main, Voice, Music, and Stage Monitor
- Unbalanced, bass reduced, hard-limited RCA output (same program as Main)

Front Panel Controls:

- Input level controls
- Prefade buttons
- Headphone jack w/ volume control

Front Panel Indicators:

- LED indicates gating (MIC inputs) and clipping status of each input.
- Compression LED indicates compression is active.
- Level display bar graph

Rear Panel Settings for each input:

- Phantom Power: Provides 24VDC nominal for condenser mic.
- Gain adjustment: Four settings 10 dB apart (30 dB total range)

Digital System:

- Sample Rate: 48 KHz
- Resolution: 24 bits overall with 56-bit EQ filters
- Latency (filters OFF): 1.5 mS

Power: 9 Watts from included 24VDC wall adapter.

Audio Specs:

- Max Output Level (balanced): +23dBm at clipping, unloaded (less 6dB @ 600 Ω load)
 - Meter zero VU (first yellow LED): +4dBm (less 6dB @ 600 Ω load)
- RCA Output Level (unbalanced): Approx. -10 dBm when compressed
- MIC Gain (To balanced output, control and preset maximum): 78 dB
- MIC Gating: Selectable, wave-sensing adaptive algorithm
- AUX Gain (To balanced output, control and preset maximum): 30 dB
- Preset attenuation (all inputs): 0 – 30 dB in 10 dB steps
- Compression Ratio (when enabled and active): 3:1
- Equivalent Input Noise:
 - MIC inputs: -118 dBv, AUX inputs: -85 dBv
- THD (@ 1 KHz, no clip indication, compressed or not): < 0.08%
- Frequency Response (-3dB, Filters flat):
 - MIC inputs: 120 Hz – 20 KHz (De-esser OFF); AUX inputs: 10 Hz – 21 KHz
 - Compressed Main RCA Output: 120 Hz – 20 KHz (all inputs)
- De-esser: Mic 1-8, ratiometric algorithm, active range 3.0 – 7.5 KHz
- Auto-EQ operating range: 140 Hz – 8 KHz
- Equalizer adjustments: (See pages 31–36)

Flow Diagram

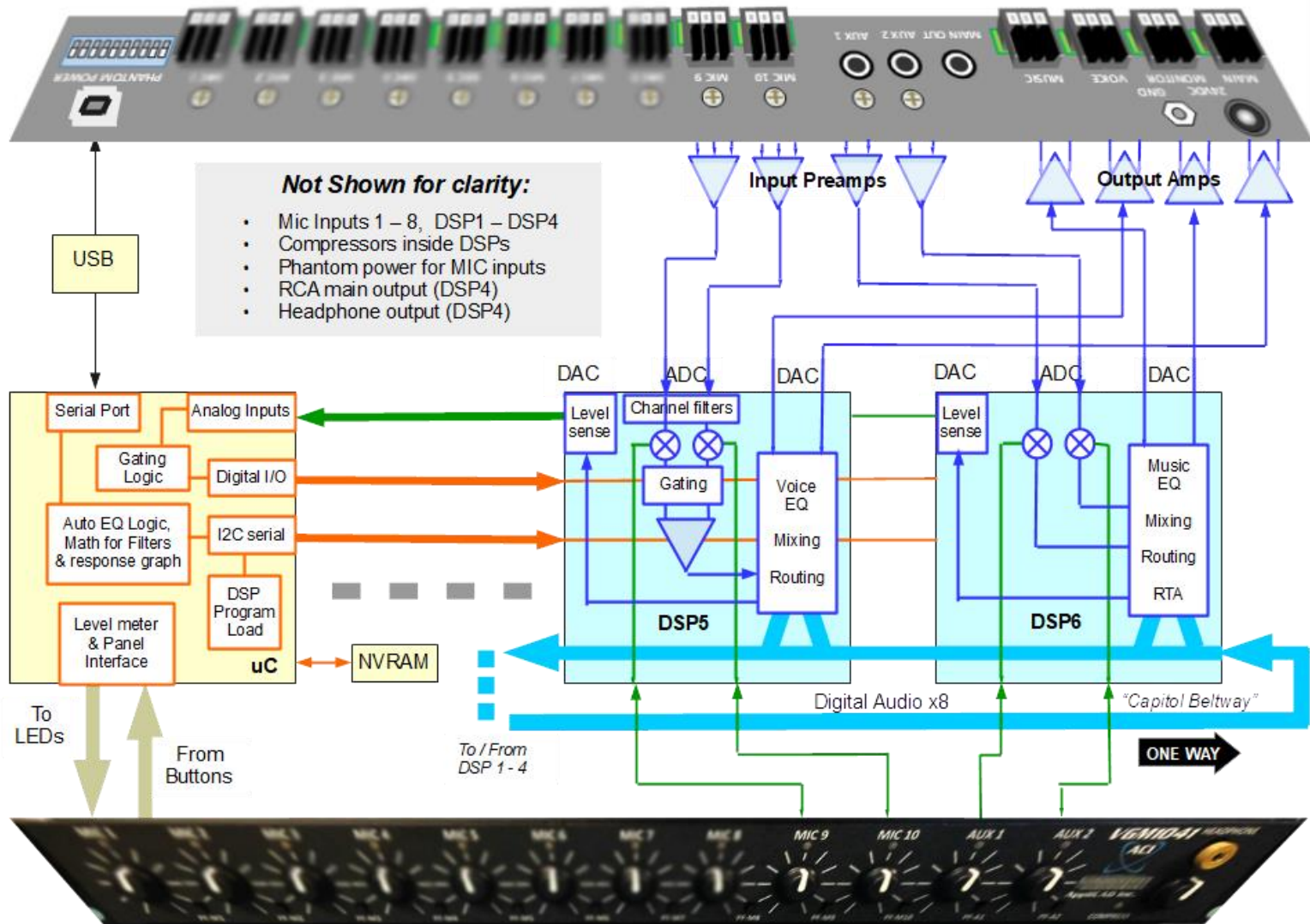

Index

Auto-EQ	38 – 39	Microphones	4, 15 – 18
Auxiliary Inputs	2, 15	Condenser	4, 18
Balanced Outputs	15, 19	EQ	35 – 37
Bench test	2 – 5	Management	9
Compression	5, 10 – 11, 29	Wireless	18
COMPRESS LED	8, 10 – 11	Wiring	4, 15
Condenser mics	4, 18	Mounting	17
Contact us	45	Music EQ	35
Cue bus (Prefade)	5, 8	Music output	19
De-Esser	29	Nodes, feedback	36
Dynamic mics	4, 18	Operating tips	9 – 11
Double-Hall	13, 42 – 43	Parametric EQ	32 – 34
Equalizer (EQ)	32 – 41	Phantom power	4, 18
factory setting	22, 34	Pink Noise Gen	37
Factory preset/reset	22	Phone number, ACI	1, 45
Factory Service	45	Power	3, 15, 44
Feature list	1	Power Amplifier	
Feedback (Acoustic)	9, 36-37	Gain adjustment	20
Gain before	10	Prefade	5, 8
Feedback (Electronic)	42	Rear panel	2 – 5, 15, 18 – 19
Filter, EQ	32 – 37	Response Graph	40 -- 41
Flow Diagram	47	Setup Screens	28, 29, 34
Front Panel	6	Specifications	46
Gain Presets	15	Stage Monitor	19, 22 – 23, 29
Gate / Clip LEDs	6, 7	Troubleshooting	44 – 45
Gating	12	USB Setup Port	23 – 27
Adjustment	30	Usage	28 -- 43
Headphone jack	3, 5	Voice EQ	
Installation & Setup	15 – 43	Adjust by ear	36
Level Meter	7	Adjust by RTA	37
Line Outputs	19	Auto-EQ	38
Main Output	2, 19	Voice Output	19
MIC Inputs	4, 15 – 18	Warranty	45
Configure as aux	31	Web site, ACI	1

